



**Russell A. Smith**

*Gurdjieff:*

# **COSMIC SECRETS**

SCANNED BY:

*pullybone*

**THE  
DOG**

Sanger, Texas

*dedicated to the premise*

# VINCIT OMNIA VERITAS

Published in the United States by

THE DOG  
Route 1, Box 619  
Sanger, Texas 76266

## THE DOG

An organization of:

**Theological Harmonistic Exercitations**

into the

**Discoveries Of Gurdjieff**

Copyright © 1993 by Russell A. Smith

All rights reserved. No part of this publication may be reproduced or transmitted in any form or by any means, electronic or mechanical, including photocopy, recording, or any information storage and retrieval system now known or to be invented, without permission in writing from the publisher, except by a reviewer, who wishes to quote brief passages in connection with a review written for inclusion in a magazine, newspaper, or broadcast.

ISBN 0-9643031-0-8

# TABLE OF CONTENTS

<i>AUTHOR'S NOTE</i> _____	iii
<i>PROLEGOMENON</i> _____	iv
<i>ACCORDING TO LAW</i> --Chapter One _____	1
The third striving remains objective ◊ All manifestations are governed by Laws ◊ The Enneagram as three symbols ◊ Law of Three ◊ Law of Seven ◊ The Octave ◊ Pythagorean Harmonies ◊ Diatonic Scale ◊ Diatonic Totality ◊ Discontinuity of vibrations ◊ Motivation behind Creation ◊ Chapter One Worksheet.	
<i>THE UNCREATION OF THE UNIVERSE</i> --Chapter Two _____	14
Changed state is the Present state ◊ The changing of the Law of Three ◊ Relationships of the three forces ◊ Separation of the three forces ◊ Corresponding correlation: ratios 12-10-8 ◊ The changing of the Law of Seven ◊ Deciphering the Enneagram ◊ The dilemma of even sevenths ◊ The Absolute's structural alterations ◊ Cosmic rumple ◊ The alignments that gave birth to the Universe ◊ Correlation between the displacement of each note ◊ Ratio of the cosmic rumple ◊ Reflections ◊ Chapter Two Project.	
<i>INFRASTRUCTURAL COGNIZANCE</i> --Chapter Three _____	35
Absolute-sun-earth-moon ◊ Mathematics of four fundamental points ◊ Three inner octaves ◊ The fate of the vibrations ◊ The unique vibrations of <u>So</u> and <u>Mi</u> ◊ Structure of scale-0 and scale-1 ◊ Octave lengths ◊ Scale-2 observations ◊ An oscillating <u>Do</u> 's point of view ◊ The appearance of Pauses ◊ Process of defining what a thing is ◊ Parts and parts-of-parts ◊ Time for <u>Ti</u> ◊ According to scale ◊ Playing with a full deck ◊ The deck of cards portrays 7 and 3 in Man ◊ 69 vibrations which define Life ◊ Sex as the Duplicating Principle ◊ Gradations in complexity/intelligence ◊ Chapter Three Worksheet.	
<i>CAUGHT IN THE COSMIC LOOP</i> --Chapter Four _____	52
Examining the vibrations between the four fundamental points ◊ Top, middle or bottom octave ◊ Dual possibilities ◊ An octave has a duality ◊ Mathematics of the duality and the range of existence ◊ <u>So</u> and <u>Mi</u> have a mutual relationship ◊ The Atom ◊ Presence of three forces--webs of harmonic stability ◊ Inevitability of oscillations ◊ Symmetrically-distanced denying force ◊ Major and minor oscillations ◊ The atom is influenced by the major oscillation ◊ Three scales of an oscillation ◊ Structure of oscillations reveals one of Life's first molecules--RNA ◊ The oscillation and transfer RNA ◊ The octave insures the accuracy of its oscillation ◊ A completing duality becomes DNA--the Master Blueprint of Life ◊ Oscillations within oscillations ◊ DNA ◊ Chapter Four Project ◊ Inexactitudes.	

*THE WAY UP WAS THE WAY DOWN*--Chapter Five \_\_\_\_\_ 73

Defining the fabric of the Universe ◊ All forces are diatonic ◊ Structurally, a trinity of three forces ◊ A diatonic trinity ◊ Mutual points of influence ◊ Flow of forces ◊ Configuration for the passage of forces ◊ Ribosomal RNA ◊ The Chord ◊ Shocking octaves ◊ Possibility of ascension ◊ Inner transition ◊ Diagram of Nutrition ◊ Passage of food, air and impressions with and without shocks ◊ Man-Angel major oscillation ◊ The symbolic Enneagram ◊ Forces are always at LA and FA ◊ The Diatonic Enneagram ◊ Begin at Mi and So ◊ Chapter Five Worksheet.

*THE UNIVERSAL COSMIC WEAVE*--Chapter Six \_\_\_\_\_ 91

Completing the structure of the Universe ◊ Multiple representations of the Laws ◊ Symbol of three forces: united and separated ◊ Transitional Symbol ◊ Symbolic eternal unchanging ◊ Three segments within four boundaries ◊ Configuring the boundaries of the three segments as octaves ◊ Absolute--Holy Sun Absolute--Universe ◊ Establishing corresponding diatonic forces in the Holy Sun Absolute ◊ The Gurdjieff Treatise ◊ Octaves that lawfully arise in the outer segment--the Universe ◊ Chronological Diagram of the Universal Cosmic Weave ◊ Mathematical progression during formation ◊ Pascal's Triangle ◊ 19 points of creation ◊ Fibonacci Series ◊ Boundaries of Creation ◊ The sixteenth octave removed ◊ Progression of Forces ◊ 47 diatonic vibrations exist in the 19 octaves of the Universe ◊ 19 relatives, 4 families ◊ Family order of occurrence ◊ A listing of the filling of an atom's energy shell ◊ Connections ◊ Two electrons share the same orbital--spin-down, spin-up ◊ Family connections ◊ The enigmatic pattern of the Periodic Table of Elements is lawfully structured ◊ The Universe begins with seven Supreme Vibrations ◊ Each octave ends with a duality ◊ Stop and Start octaves ◊ Placement of elements ◊ Mr. Gurdjieff's 'inner Ansapalnian-octave' ◊ The final element--Gurdjine ◊ Chapter Six Project.

*TRAVERSING SUSPENDED CONTINUITY*--Chapter Seven \_\_\_\_\_ 135

Highlights of this exposition ◊ Traversing the obligatory-gaps ◊ Outer octaves ◊ Coinciding vibrations are felt ◊ Gaps between major oscillations ◊ Oscillations connect centers ◊ Three-fold aspect ◊ The Sequence ◊ LA and FA outer octaves ◊ Seventh family member is an ending and a beginning ◊ Defining the unknown previous scale ◊ Spiritual and Physical range ◊ Seven brains come into being ◊ REASON makes the difference ◊ Sevenfoldness ◊ Octaves within Stopinders ◊ Ti's location ◊ Spanning the intervals ◊ Why Re is the bottom ◊ Why and where the fundamental outer cycle stops ◊ Three particularities of the fifth Stopinder ◊ The sixteenth octave--last and first ◊ Similarities to the already arisen--Life ◊ A journey beyond-beyond--some greater octave ◊ Interpreting the arrows of ascension and descension ◊ Gravity ◊ Mi-So area of coincidence--a unique manifestation ◊ Electromagnetic Spectrum ◊ Magnetism ◊ Strong and Weak nuclear forces ◊ The After Math ◊ Chapter Seven Worksheet.

*ENDNOTES* \_\_\_\_\_ 160

*FOUNDATIONAL LITERATURE* \_\_\_\_\_ 162

*INDEX OF TERMS* \_\_\_\_\_ 164

*INDEX OF DIAGRAMS* \_\_\_\_\_ 165

## AUTHOR'S NOTE

As we journey into the vast, intricate terrain of the laws of World-creation and World-maintenance, it will serve us well: *to know* where we are; *remember* where we have been; *and understand* where we are going. Since, in our endeavors we shall not only venture horizontally--along the same scale, but vertically--traversing many scales, the following guideposts have been added to help the intuitive traveler find his way:

### Scale Model

Scale-? = "DO" "RE" "MI" "FA" "SO" "LA" "TI" "DO"  
THE UNKNOWN SCALE

Scale-0 = DO RE MI FA SO LA TI DO  
THE SCALE OF TOTALITY--"ONENESS"

Scale-1 = DO RE MI FA SO LA TI DO  
THE NATURAL MATHEMATICAL SCALE--"PARTS"

Scale-2 = Do Re Mi Fa So La Ti Do  
THE SCALE OF MECHANICALNESS--"PARTS OF PARTS"

Scale-3 = do re mi fa so la ti do  
THE INNERMOST SCALE--"PARTS OF PARTS OF PARTS"

All Scales = Do Re Mi Fa So La Ti Do  
THE GENERIC SCALE

# PROLEGOMENON

One fundamental truth ringing forth from the chronicles of humanity is the assertion that Man--“the pinnacle of Creation”--is made in the *image* of God. A **thoroughly humbling realization**; but, what does being made in the *image* of God really mean; and, if this *image* of God is a *self evident truth* for us, then it should also be *self evident* in the *structure* of the Universe. Conceivably, if we can assimilate this *axiomatic image* [an underlying common structure in both Man and the Universe] we might be able to actualize ourselves in consonance with it, and finally begin our returning ascent back to the source of the flow.

Mankind has tried to discern these answers through Religion, Science, Yoga, Zen, Mysticism, the Occult, or by various other forms of Old and New Age spiritual philosophy. Numerous, ideological doctrines have been dispersed into Life; some prove to be valuable, while others miss the mark. Although most are essentially Spiritual, many become contradictory and dogmatic--making it difficult to receive anything from them. So, we travel onward...wishing that our next encounter will be more fulfilling than the last.

Personally, my journey was accentuated in the late 1970's, when I found a system of philosophy that, without fail, *hit the mark every time*. A philosophy predicated on one central question:

## **WHAT IS THE SENSE AND SIGNIFICANCE OF LIFE IN GENERAL, AND PARTICULARLY, THE AIM AND PURPOSE OF THE LIFE OF MAN?**

Fortunately, one man formulated this question and then unceasingly devoted his lifetime toward finding the answer.

This book is offered, not as a recapitulation of “the Gurdjieff Question”, which it has subsequently come to be called, but rather, as an exposition on what we call “the Gurdjieff Answers”.

**ANSWERS SO POWERFUL THAT THEIR KNOWLEDGE CAN  
NOT ONLY EFFECTUATE A SPIRITUAL EVOLUTION IN MAN,  
BUT POSSIBLY, A SPIRITUAL REVOLUTION IN MANKIND.**

We can find these answers purposefully concealed in Gurdjieff’s writings. Gurdjieff addresses this idea in the following excerpt:

“He himself [Gurdjieff] used to listen to chapters read aloud and if he found that the key passages were taken too easily--and therefore almost inevitably too superficially--he would rewrite them in order, as he put it, to ‘bury the dog deeper’. When people corrected him and said that he surely meant ‘bury the bone deeper’, he would turn on them and say it is not ‘bones’ but the ‘dog’ that you have to find.”<sup>1</sup>

Having spent much of my adult life immersed in the Gurdjieff Work, I have been extremely fortunate to uncover several of the “dogs” buried within Mr. Gurdjieff’s literature and am invariably amazed by their ever increasing breadth of application. Although I continue to ascertain new concepts predicated on these discoveries, the cohesiveness of the material already amassed has reached a point where I am compelled to, hopefully, get it in the hands of beings who have also pursued--in one way or another--the inevitable “Gurdjieff Question”. Perhaps, the information shared here will assist...in Life’s most meaningful quest.

“If you help others, you will be helped, perhaps tomorrow, perhaps in 100 years, but you will be helped. Nature must pay off the debt....It is a mathematical law and all life is mathematics.”<sup>2</sup>

--GURDJIEFF

**ASCENDING**

**DO**

## CHAPTER ONE

# ACCORDING TO LAW

“All the beings of this planet then began to work in order to have in their consciousness this Divine function of genuine conscience, and for this purpose, as everywhere in the Universe, they transubstantiated in themselves what are called the ‘**being-obligolnian-strivings**’ which consist of the following five, namely:

“**The first striving:** to have in their ordinary being-existence everything satisfying and really necessary for their planetary body.

“**The second striving:** to have a constant and unflagging instinctive need for self-perfection in the sense of being.

“**The third:** the conscious striving to know ever more and more concerning the laws of World-creation and World-maintenance.

“**The fourth:** the striving from the beginning of their existence to pay for their arising and their individuality as quickly as possible, in order afterwards to be free to lighten as much as possible the Sorrow of our COMMON FATHER.

“**And the fifth:** the striving always to assist the most rapid perfecting of other beings, both those similar to oneself and those of other forms, up to the degree of the sacred ‘Martfotai’ that is up to the degree of self-individuality.”<sup>3</sup>

Our study into the objective truths [“dogs”] buried in Gurdjieff’s writings must begin with the third striving; for *it is the only striving that can remain objective throughout.*

All manifestations in the universe--including “Man’s possibilities”--are governed by the laws of World-creation and World-maintenance; therefore, it is fortunate that we will be able, with just **basic** mathematical and scientific knowledge, to have a thorough understanding of them.

# THE ENNEAGRAM

In Gurdjieff's cosmology, the Universe is represented by the symbol of the Enneagram. The Enneagram itself is composed of *three symbols*.

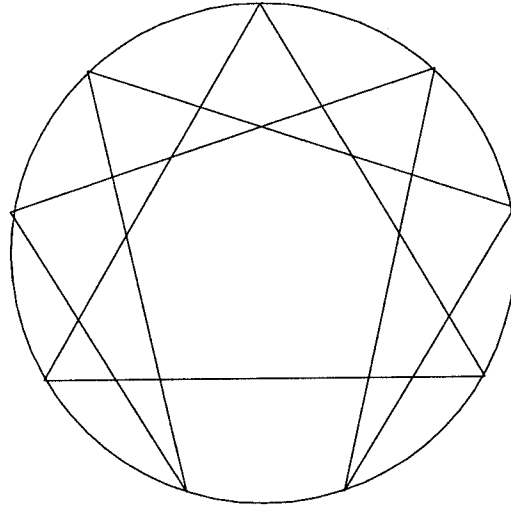

**First**, there is a circle in which EVERYTHING is contained; it represents Oneness, Unity, God, the Absolute.

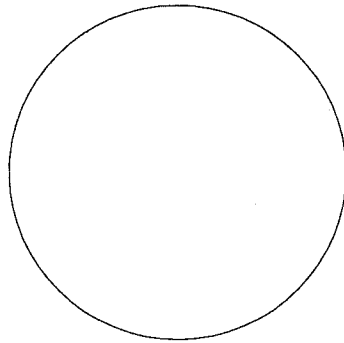

**Second**, within the circle there is a triangle; it represents the three independent forces present in every whole phenomenon.

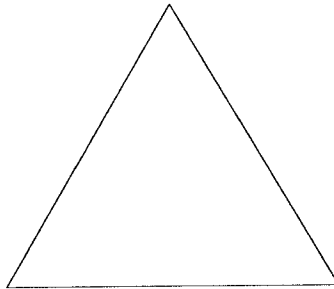

According to Gurdjieff, the *Law of Three* is one of the two fundamental laws of the Universe.

“A new arising from the previously arisen through the “Harnel-miaznel,” the process of which is actualized thus: the higher blends with the lower in order to actualize the middle and thus becomes either higher for the preceding lower, or lower for the succeeding higher;’ and as I already told you, this Sacred-Triamazikamno consists of three independent forces...”<sup>4</sup>

We can see three forces...everywhere, *if we look*. In Christianity, the three forces represent the Trinity: the Father, the Son, and the Holy Spirit. In Hinduism, they are Brahma, Vishnu, and Shiva. In Chemistry, the smallest constituents of matter [atoms] contain three forces: protons, neutrons, and electrons. In atoms, the protons and neutrons have their own three inner constituents called “quarks”. There are three primary colors; three notes in a chord; and so forth.

**IN ALL THINGS AND IN ALL EVENTS, WE CAN FIND THE LAW OF THREE.**

The **third** symbol in the Enneagram represents the first fundamental law of the Universe. Gurdjieff referred to it as the *Law of Seven*, the *Law of Vibrations*, the *Law of Octaves*, or the *Law of Heptaparaparshinokh*.

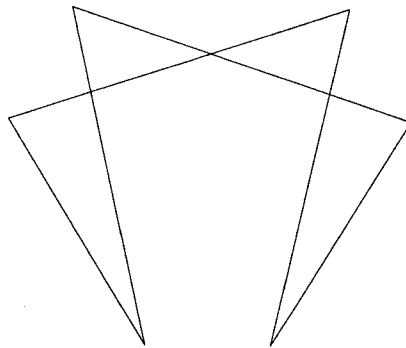

“The-line-of-the-flow-of-forces-constantly-deflecting-according-to-law-and-uniting-again-at-its-ends.’

“This sacred primordial cosmic law has seven deflections or, as it is still otherwise said, seven ‘centers of gravity’ and the distance between each two of these deflections or ‘centers of gravity’ is called a ‘Stopinder-of-the-sacred-Heptaparaparshinokh.’

“This law, passing through everything newly arising and everything existing, always makes its completing processes with its seven Stopinders.”<sup>5</sup>

In *Webster's New World Dictionary--Second College Edition*, we find in the definition of an octave, the inclusion of a restoring DO [an eighth tone]; which is--in reality--the first tone of the next octave. That definition is as follows:

“The eighth full tone above a given tone, having *twice* as many vibrations per second, or below a given tone, having *half* as many vibrations per second.” Also, “the *interval of eight diatonic degrees* between a tone and either of its octaves.”

From these definitions, we can easily comprehend two of the main features of this law: **a sevenfold structure; and a requisite inherency to double or half.** For example, a musical octave contains seven notes DO, RE, MI, FA, SO, LA, and TI. Also, musical octaves always indicate a doubling or halving of vibrations; that is, Middle C is at 256 vibrations per second and High C is at 512 vibrations per second. Other examples of the Law of Seven are: the splitting of light through a prism into seven colors; or the rate of decay of radioactive material, which is calculated in terms of its half-life.

**SINCE THE BEST REPRESENTATION OF THIS LAW HAS BEEN RIGHT BEFORE OUR EARS ALL OUR LIVES, HIDING IN THE MUSICAL OCTAVE, WE WOULD BE WELL ADVISED TO BRING IT BEFORE OUR EYES AND USE THE MUSICAL OCTAVE AS OUR MODEL.**

Music starts with 1 vibration per second. This doubles to 2 vibrations per second and forms an octave. If we double it to 4 vibrations per second, we create another octave. If we continue this doubling--8 vibrations per second, 16 vibrations per second, 32 vibrations per second, 64 vibrations per second, 128 vibrations per second--when we reach 256 vibrations per second we will be at what music defines as “Middle C”. If we double it again to 512 vibrations per second we will be at “High C”. These are the basics from which we shall begin. Upon them we can effectuate a detailed examination into the *diatonic structure* of the octave. Note: *Between the initial vibration and either double or half of that vibration, six “additional” diatonic vibrations come into existence.* These six, additional vibrations occur at *specific ratios*, which were first documented by Pythagoras--a philosopher and mathematician in the 6th century B.C.--and are now fittingly called the **Pythagorean Harmonies.**

DO - which we shall refer to as the “ascending DO”, has the value 1. The other vibrations are simply increasing ratios of this vibration.

RE - exceeds the vibration of the ascending DO by  $1/8$  ( $1+1/8$ );  
or the ratio: 9 to 8 ( $9/8$ ); or the factor: 1.125.

MI - exceeds the vibration of the ascending DO by  $1/4$  ( $1+1/4$ );  
or the ratio: 5 to 4 ( $5/4$ ); or the factor: 1.25.

FA - exceeds the vibration of the ascending DO by  $1/3$  ( $1+1/3$ );  
or the ratio: 4 to 3 ( $4/3$ ); or the factor: 1.333.

SO - exceeds the vibration of the ascending DO by  $1/2$  ( $1+1/2$ );  
or the ratio: 3 to 2 ( $3/2$ ); or the factor: 1.5.

LA - exceeds the vibration of the ascending DO by  $2/3$  ( $1+2/3$ );  
or the ratio: 5 to 3 ( $5/3$ ); or the factor: 1.666.

TI - exceeds the vibration of the ascending DO by  $7/8$  ( $1+7/8$ );  
or the ratio: 15 to 8 ( $15/8$ ); or the factor: 1.875.

DO - which we shall refer to as the “descending DO” completes the octave,  
and is twice the vibration of the ascending DO.

William Braid White’s book, *Piano Tuning and Allied Arts*, verifies these Pythagorean Harmonies.

“These ratios may readily be verified by taking a string of convenient length, say 60 inches, on a monochord, tuning it to C and then successively shortening it in the reciprocals of the figures shown. It will then be found that a speaking length:

of 53.33 inches ( $60 \div 9/8$ ) will sound D,  
one of 48 inches ( $60 \div 5/4$ ) will give E,  
one of 45 inches ( $60 \div 4/3$ ) will give F;  
and so on.

INTERVAL:	I	II	III	IV	V	VI	VII	VIII
NAME:	C	D	E	F	G	A	B	C
FREQUENCY								
RATIO TO C:	1	$9/8$	$5/4$	$4/3$	$3/2$	$5/3$	$15/8$	$2/1$

Or in other words, the relation C to D is the same as the ratio 8 to 9.

The relation C to E is likewise 4 to 5.

The relation C to F is 3 to 4,

C to G is 2 to 3,

C to A is 3 to 5,

C to B is 8 to 15, and

C to its octave is 1 to 2.”<sup>6</sup>

## THIS INVERSE RELATIONSHIP--THE LENGTH OF A STRING TO ITS FREQUENCY--REVEALS THE “DIATONIC SCALE”.

### DIATONIC SCALE

DO	2. vibrations/sec. (descending <u>Do</u> )	2
TI	1.875 or 1 7/8	or 15/8
LA	1.666 or 1 2/3	or 5/3
SO	1.5 or 1 1/2	or 3/2
FA	1.333 or 1 1/3	or 4/3
MI	1.25 or 1 1/4	or 5/4
RE	1.125 or 1 1/8	or 9/8
DO	1. vibration/sec. (ascending <u>Do</u> )	1

Note: *Above*, the ascending octave (1 to 2) is calculated by multiplying the ascending DO-(1) times the *diatonic ratios*. *Below*, a descending octave (1 to 1/2) is computed by multiplying the descending DO-(1) times *1/2 the diatonic ratios*.

DO	1. (descending <u>Do</u> )	1
TI	.9375 or	15/16
LA	.8333 or	5/6
SO	.75 or	3/4
FA	.6666 or	2/3
MI	.625 or	5/8
RE	.5625 or	9/16
DO	.5 (ascending <u>Do</u> )	1/2

To establish a collective understanding, we will call ANY TOTALITY or ANY PART OF A TOTALITY that conforms to these ratios--“DIATONIC”.

To calculate the major scale from Middle C to High C, we simply apply the diatonic ratios to the ascending vibration of Middle C (256); or apply 1/2 of the diatonic ratios to the descending vibration of High C (512). In our calculations, we shall use the formula **ascending vibration** times the diatonic ratios.

### OCTAVE FROM MIDDLE C TO HIGH C

DO	=	256	x	2/1	=	512	High C
TI	=	256	x	15/8	=	480	B
LA	=	256	x	5/3	=	426.666	A
SO	=	256	x	3/2	=	384	G
FA	=	256	x	4/3	=	341.333	F
MI	=	256	x	5/4	=	320	E
RE	=	256	x	9/8	=	288	D
DO	=	256	x	1/1	=	256	Mid C

If we look at the octave in terms of the total *increase* or *decrease* in vibrations, then the octave from Middle C to High C has an *increase* of 256 vibrations; the octave from High C to Middle C has a *decrease* of 256 vibrations. The increase *itself* can be viewed as an octave, as a totality that increases from “nothing to all”; in this case, starting at 0 and increasing to 256. The decrease can also be viewed as an octave, but this time, as a totality decreasing from “all to nothing”; 256 decreasing to 0.

### THE TOTALITY OF 256 VIBRATIONS

DO	256	=	ALL
TI	224	=	7/8 of the totality
LA	170.666	=	2/3 of the totality
SO	128	=	1/2 of the totality
FA	85.333	=	1/3 of the totality
MI	64	=	1/4 of the totality
RE	32	=	1/8 of the totality
DO	0	=	NOTHING

**ANY WHOLE PHENOMENON CAN BE CALCULATED AS AN OCTAVE, AS A “SOMETHING” THAT RUNS FROM ITS ALLNESS TO ITS NOTHINGNESS, OR VICE VERSA, DIVIDING THE TOTALITY “DIATONICALLY” BY THE RATIOS: 1/8, 1/4, 1/3, 1/2, 2/3, AND 7/8.**

The progression and affinity of an octave's vibrations can best be observed in the octave of 24 (DO-24 to DO-48), as it is the smallest whole numbered octave that has its eight diatonic degrees at whole numbers.

<b>Natural Octaves</b>	<b>Totality of Phenomenon</b>
↓ Interval ↓	↓ Interval ↓
RE 108	RE 12
12	12
DO 96	DO 0
DO 96	DO 48
6	6
TI 90	TI 42
10	10
LA 80	LA 32
8	8
SO 72	SO 24
8	8
FA 64	FA 16
4	4
MI 60	MI 12
6	6
RE 54	RE 6
6	6
DO 48	DO 0
DO 48	DO 24
3	3
TI 45	TI 21
5	5
LA 40	LA 16
4	4
SO 36	SO 12
4	4
FA 32	FA 8
2	2
MI 30	MI 6
3	3
RE 27	RE 3
3	3
DO 24	DO 0

If we examine the octaves of 24 and 48 together [or any set of two or more consecutive octaves], we can begin to see a pattern developing. Between MI and

FA, and between TI and DO, there is a *retardation* in the rate of increase of vibrations. The MI-FA and TI-DO intervals are *smaller* than the neighboring intervals. After each of these intervals, there is an interval *twice as large*....Why? What does this mean?

One contribution of Gurdjieff's cosmology is the study of this retardation, or discontinuity of vibrations, which occurs between MI-FA and between TI-DO. The gist of this part of Gurdjieff's teaching conduces to this: that at these two intervals things either cease or deviate, "there are no straight lines in nature"; and also, how Man [by applying "conscious shocks"] can acquire the ability to, ultimately, traverse these intervals.

Nearly every author who has tackled Gurdjieff's ideas has devoted chapters regarding these two intervals. They have used them to explain everything from why it stops raining, to how Christianity became the Inquisition. This author will not try to expand on their explanations; but rather, will *mathematically reveal the scaffolding underlying the structure of life itself* and expose the veracity behind these two intervals, thus, making them comprehensible and understandable to all. To do this we must decipher the *diatonic relationship* of the notes, and ask *why RE, MI, FA, SO, LA, and TI* are 1/8, 1/4, 1/3, 1/2, 2/3, and 7/8 of the whole; *and why not* in some other configuration.

*If we can answer this question we will have ultimately set the stage to answer a similar question, one that has been on the mind of Man since the dawn of reason:*

## WHY ARE THINGS THE WAY THEY ARE?

As a launching point, let us consider Gurdjieff's treatise concerning the motivation behind Creation [God's "forced need" to create the Universe].

"In the beginning, when nothing yet existed and when the whole of our Universe was empty endless space with the presence of only the prime-source cosmic substance 'Etherokrilno,' our present Most Great and Most Most Holy Sun Absolute existed alone in all this empty space, and it was on this then sole cosmic concentration that our UNI-BEING CREATOR with HIS cherubim and seraphim had the place of HIS most glorious Being.

“It was just during this same period of the flow of time that there came to our CREATOR ALL-MAINTAINER the forced need to create our present existing ‘Megalocosmos,’ i.e., our World.

“From the third most sacred canticle of our cherubim and seraphim, we were worthy of learning that our CREATOR OMNIPOTENT once ascertained that this same Sun Absolute, on which HE dwelt with HIS cherubim and seraphim was, although almost imperceptibly yet nevertheless gradually, diminishing in volume.

“As the fact ascertained by HIM appeared to HIM very serious, HE then decided immediately to review all the laws which maintained the existence of that, then still sole, cosmic concentration.

“During this review our OMNIPOTENT CREATOR for the first time made it clear that the cause of this gradual diminishing of the volume of the Sun Absolute was merely the Heropass, that is, the flow of Time itself.

“Thereupon our ENDLESSNESS became thoughtful, for in HIS Divine deliberations HE became clearly aware that if this Heropass should so continue to diminish the volume of the Sun Absolute, then sooner or later, it would ultimately bring about the complete destruction of this sole place of HIS Being.

“And so, my boy, in view of this, our ENDLESSNESS was then just compelled to take certain corresponding measures, so that from this Heropass the destruction of our Most Most Holy Sun Absolute could not eventually occur.

“Further, again from the sacred canticle of our cherubim and seraphim, but this time the fifth sacred canticle, we were worthy of learning that after this Divine ascertainment of HIS, our ENDLESSNESS devoted HIMSELF entirely to finding a possibility of averting such an inevitable end, which had to occur according to the lawful commands of the merciless Heropass, and that after HIS long Divine deliberations, HE decided to create our present existing ‘Megalocosmos.’

“In order that you may more clearly understand how our ENDLESSNESS decided to attain immunity from the maleficent

action of the merciless Heropass and of course how HE ultimately actualized it all, you must first of all know that before this, the Most Most Holy Sun Absolute was maintained and existed on the basis of the system called 'Autoegocrat,' i.e., on that principle according to which the inner forces which maintained the existence of this cosmic concentration had an independent functioning, not depending on any forces proceeding from outside, and which were based also on those two fundamental cosmic sacred laws by which at the present time also, the whole of our present Megalocosmos is maintained and on the basis of which it exists, and, namely, on the basis of those two fundamental primordial sacred cosmic laws, called the sacred Heptaparaparshinokh and the sacred Triamazikamno." <sup>7</sup>

## CHAPTER ONE WORKSHEET

1. Calculate the octave of 100.

DO = 200  
 TI =  
 LA =  
 SO =  
 FA =  
 MI =  
 RE =  
 DO = 100

2. Calculate the octave of 72.

DO = 144  
 TI =  
 LA =  
 SO =  
 FA =  
 MI =  
 RE =  
 DO = 72

4. Calculate the ascending and descending octaves of 1200 and 3000.

DO =	DO =	DO =
TI =	TI =	TI =
LA =	LA =	LA =
SO =	SO =	SO =
FA =	FA =	FA =
MI =	MI =	MI =
RE =	RE =	RE =
DO = 1200	DO = 3000	
TI =	TI =	
LA =	LA =	
SO =	SO =	
FA =	FA =	
MI =	MI =	
RE =	RE =	
DO =	DO =	

3. Calculate: 80, 96, and 360 as **totalities**; that is, as octaves from **all to nothing**.

DO = 80	DO = 96	DO = 360
TI =	TI =	TI =
LA =	LA =	LA =
SO =	SO =	SO =
FA =	FA =	FA =
MI =	MI =	MI =
RE =	RE =	RE =
DO = 0	DO = 0	DO = 0

**RE**

## CHAPTER TWO

# THE UNCREATION OF THE UNIVERSE

“Now, my boy, listen further very attentively.

“And so, in the beginning as I have already told you, our Most Most Holy Sun Absolute was maintained by the help of these two primordial sacred laws; but then these primordial laws functioned independently, without the help of any forces whatsoever coming from outside, and this system was still called only the ‘Autoegocrat.’

“And so, our ALL-MAINTAINING ENDLESSNESS decided to change the principle of the system of the functionings of both of these fundamental sacred laws, and, namely, HE decided to make their independent functioning dependent on forces coming from outside.

“And so, in consequence of the fact that for this new system of functioning of the forces which until then maintained the existence of the Most Most Holy Sun Absolute, there were required outside of the Sun Absolute corresponding sources in which such forces could arise and from which they could flow into the presence of the Most Most Holy Sun Absolute, our ALMIGHTY ENDLESSNESS was just then compelled to create our now existing Megalocosmos with all the cosmoses of different scales and relatively independent cosmic formations present in it, and from then on the system which maintained the existence of the Sun Absolute began to be called Trogoautoegocrat.

“Our COMMON FATHER OMNI-BEING ENDLESSNESS, having decided to change the principle of the maintenance of the existence of this then still unique cosmic concentration and sole place of HIS most glorious Being, first of all altered the process itself of the functioning of these two primordial fundamental sacred laws, and HE actualized the greater change in the law of the sacred Heptaparaparshinokh.”<sup>8</sup>

Gurdjieff's masterful treatise of a "forced need" to create the universe explains why the two fundamental laws had to be changed. Most philosophic, religious, and scientific beliefs contain this idea...that at some point a transition occurred; but Gurdjieff goes beyond, opening the *possibility* to actually conceive the moment of creation itself. In pursuit of this possibility, our investigations will begin with the two fundamental laws. We can observe and define these laws in their changed state since their *changed state* is the *present state* of the Universe.

*But what were the two laws like before they were changed?*

*How were they changed?*

*Which law was changed first?*

*Why was the greater change in the Law of Heptaparaparshinokh?*

*How did this "changing" result in the Universe becoming the Universe?*

**Is it actually possible**--with the information hidden by Gurdjieff--to answer these questions? The only way to find out is to "uncover" and "assimilate" the clandestine "dogs" buried in Gurdjieff's writings; perhaps then, we will be able to view the Universe *before* Creation, *at the moment of* Creation, and ultimately *watch in reverence* as the World begins.

## THE CHANGING OF THE LAW OF THREE

The first "dog" that we shall try to exhume comes from Mr. Gurdjieff's teachings on triads, and the aggregation of the three forces. Here, **six triads** or **six combinations of the three forces** are possible:



The *positive*, *negative*, and *neutralizing principles*, or three forces, can only manifest through six triads. Then, Gurdjieff refers to a *seventh triad*; one that is only available to the Absolute. **A triad in which the three forces are united.**

“There can be seven combinations of forces, one of them incomprehensible to the human mind, since in this triad each force occupies each place.”<sup>9</sup>

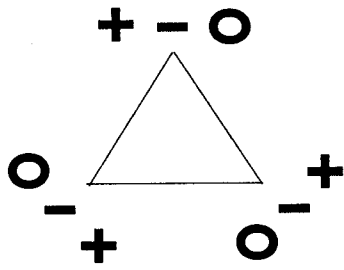

If we cogitate on these ideas...faint parts of a buried canine start to reveal themselves. “*For the Absolute the three forces are united.*” “*For the Universe the three forces are separated.*” Could this imply that the **changing of the Law of Three involved separating the three forces from each other?** If this is true, it would also explain **why** separating the forces caused Creation. When the three forces were separated, *it must have sparked an inherent striving to reblend;* and **this striving to reblend,** could explain **the incessant urge underlying Creation.**

This brings us to another question:

*Where ARE the three separated forces?*

**SEPARATION OF THE THREE FORCES**

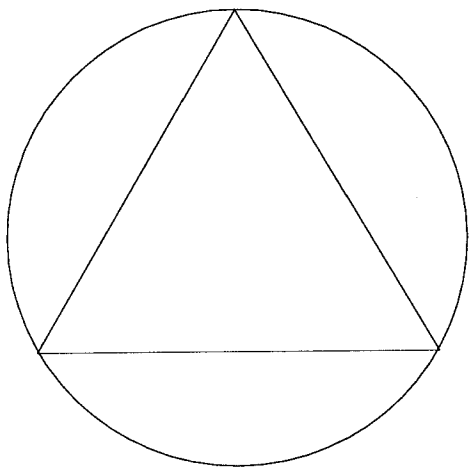

In the Enneagram, an equilateral triangle represents the three separated forces. It divides the circle into three equal parts. Could the points of the triangle,

at 1/3, 2/3, and 3/3 of the circle, be literally *pointing* to the forces? Fortunately, Gurdjieff helps us here by not burying the dog too deep. In fact, in *Views From the Real World* it is not buried at all....It is just lying there.

“A man should be able to give a total of 30 for everything taken together. This figure can be obtained only if each center can give a certain corresponding number--for instance, 12 + 10 + 8.

“If 30 is correctly a true manifestation of man and this 30 is produced by three centers in a corresponding correlation, then it is imperative that the centers should be in this correlation.”<sup>10</sup>

In Gurdjieff's teachings, Man has seven centers: Higher Mental Center, Higher Emotional Center, Intellectual Center, Emotional Center, Moving Center, Instinctive Center, and Sex Center. Each center is an independent *brain* with its own memories, associations, and will. The higher mental center and the higher emotional center are fully functional, but Man, in his present state, has little or no contact with them. At the other end of the stick, the sex center is designed to begin functioning later in life, and will function properly *if* the moving, instinctive, emotional, and intellectual centers function properly.

Gurdjieff's main emphasis was directed toward the instinctive, moving, emotional, and intellectual centers. If these centers worked at their full capacity, Man would have contact with his two higher centers. The functioning of higher centers is quite miraculous; and explains why some of Man's "higher" moments seem to go beyond the "sensual-perceived-reality" of his lower centers.

In addition, Gurdjieff depicts Man as a three-story factory; his moving and instinctive centers are in the *lower story*, his emotional center is in the *middle story*, and his intellectual center is in the *upper story*. This trinity in Man, as in everything, arises from the three primordial forces. In *All and Everything, First Series, Second Book*, pages 778-780, Gurdjieff identifies the moving and instinctive centers (the lower story) as the denying force, the emotional center (the middle story) as the neutralizing force, and the intellectual center (the upper story) as the affirming force. Later, we will explore these ideas in greater detail. For now, we can use this knowledge to help us decipher the above passages. The key in the phrase, is "*it is imperative that the centers should be in this correlation*"; and "*this correlation*" is expressed by the **ratios: 12, 10, and 8.**

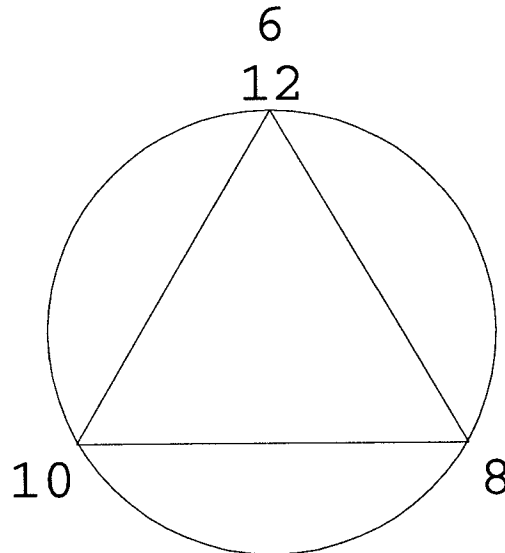

If we place these ratios at the points of the Enneagram's triangle, we would form a descending octave from 12 to 6; or an ascending octave from 6 to 12. Mathematically, we can verify that the numbers 8, 10, and 12 are at perfect **thirds** of this totality; in the octave from 6 to 12, ( $8 = 1/3$ ), ( $10 = 2/3$ ), and ( $12 = 3/3$ ).

Gurdjieff's clue, **three centers--in 12, 10, and 8 correlation**, confirms the precise location of the three separated forces, placing them at  $3/3$ ,  $2/3$ , and  $1/3$  of the whole.

By unifying what we have learned so far we can make these assertions: *For the Absolute the three forces unite at each place; for the Universe the three forces are separated*, that is, in the ratios: 12, 10, and 8 ( $3/3$ ,  $2/3$ , and  $1/3$  of the whole).

If we diagram this idea *in the form of an octave* we get the following:

### ABSOLUTE

DO = First, Third, & Second Forces  
 TI = First, Third, & Second Forces  
 LA = First, Third, & Second Forces  
 SO = First, Third, & Second Forces  
 FA = First, Third, & Second Forces  
 MI = First, Third, & Second Forces  
 RE = First, Third, & Second Forces

### UNIVERSE

\* DO =  $3/3$  First Force  
 TI =  $7/8$   
 \* LA =  $2/3$  Third Force  
 SO =  $1/2$   
 \* FA =  $1/3$  Second Force  
 MI =  $1/4$   
 RE =  $1/8$

\* the forces in the Universe correspond to the diatonic DO, LA, and FA

This idea--forces united; then separated--can also be shown graphically.

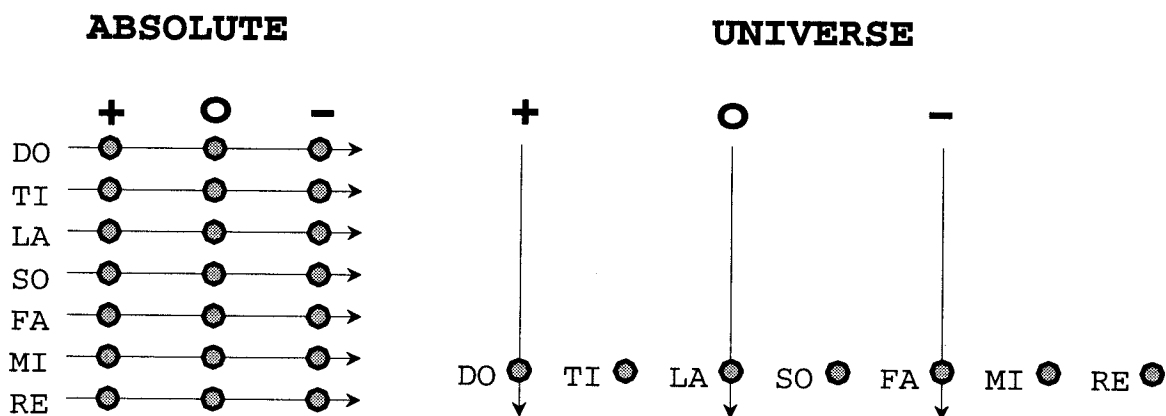

Our investigations into the changing of the Law of Three have proved to be most illuminating. We have already deduced: (a) **the three forces were united**; and then, (b) **they were separated**. We have also unearthed, in the totality of the octave: (c) **the precise, mathematical location of the three separated forces**.

## THE CHANGING OF THE LAW OF SEVEN

With this accomplished, we shall now embed our shovels in “the changing of the Law of Seven”. Note: A good place to start digging is in the octave of 168.

### Separated Forces / Even-Thirds

#### Octave Structure / Diatonic

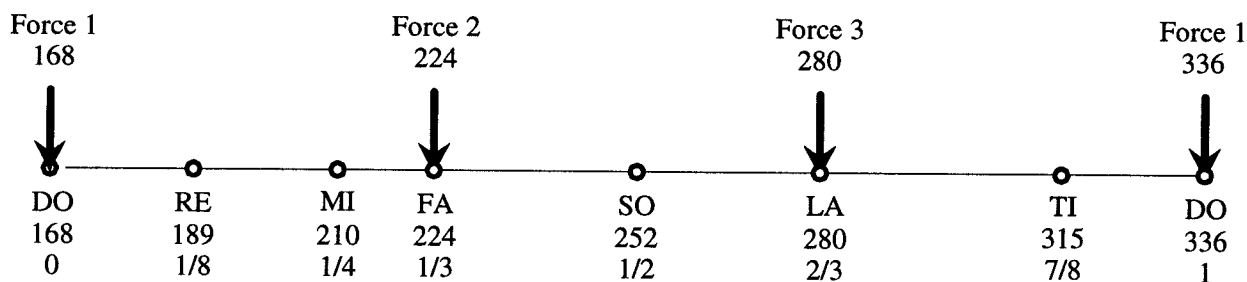

**The structure is definable.** *It consists of eight diatonic vibrations, and three separated forces.* Note: **The diatonic structure of the Law of Seven is in common alignment with the three separated forces.** This is the present state of the Universe! We can answer the question, “Why was the greater change in the

Law of the sacred Heptaparaparshinokh?”, by deducing that a greater change in this Law was required in order to achieve the present, *common alignment* with all three separated forces. To answer our remaining questions, we must first discover what the structure of the Law of Seven was *before* it became aligned.

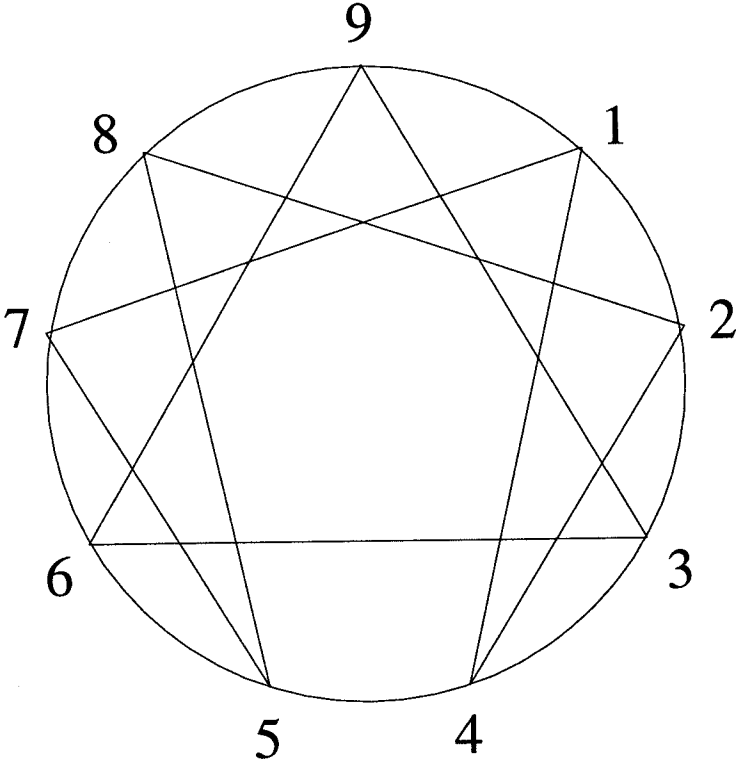

By deciphering the Enneagram symbol we can find the next answer we are seeking. The Enneagram is a circle divided into nine equal segments--numbered 1 through 9.

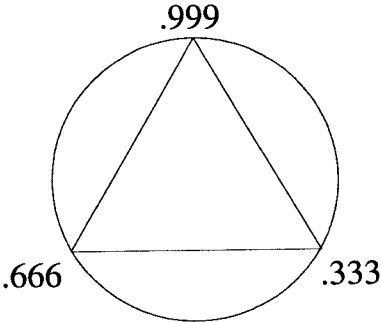

First, we will **divide** the *oneness* of the Absolute by the Law of *Three*, or three forces. The result is the pure recurring decimal .333..., which represents **one of the three forces**; adding a **second** force, totals .666...; and a **third**, .999...

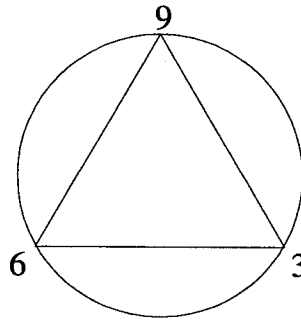

Placing these results on the Enneagram reveals that the triangle symbol connects .333 to .666 to .999 at points 3 - 6 - 9.

Second, we will **divide** the *oneness* of the Absolute by the Law of *Seven*. From this calculation we get another pure recurring decimal .142857..., which represents one seventh of the Absolute, or **one note in the Law of Seven**; adding the **second** note would give .285714..., the **third** .428571..., the **fourth** .571428..., the **fifth** .714285..., the **sixth** .857142..., and the **seventh** .999... By aligning these

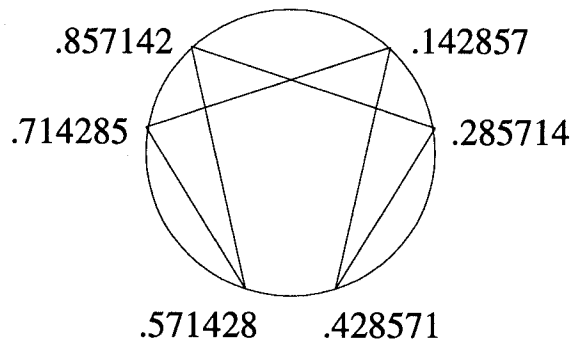

decimals with the Law of Seven symbol, we find that the symbol connects: .142857 to .428571 to .285714 to .857142 to .571428 to .714285 to .142857 at the points 1 - 4 - 2 - 8 - 5 - 7 - 1.

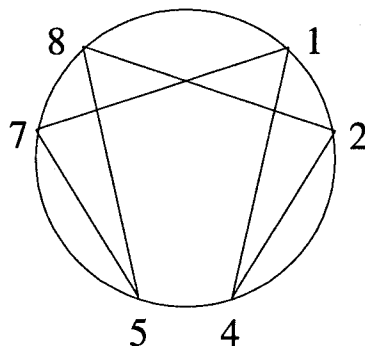

The points (1 - 4 - 2 - 8 - 5 - 7) in the Law of Seven symbol are **connected** in the precise mathematical sequence of the pure recurring decimal .142857...

This knowledge (that one Law is defined in “mathematical thirds of the Absolute”-- $1\div 3$ ; and the other, in “mathematical sevenths”-- $1\div 7$ ) is probably familiar to anyone who has ever studied the Enneagram...but is this factual? We know from our previous investigations that the three forces “do divide the octave into even thirds”, but the diatonic scale “does not divide the octave into even sevenths”. Then why is the Enneagram’s symbology of *even sevenths* so specific?

Eureka! Perhaps the Enneagram contains an esoteric representation of the original structure of the Law of Seven “before it was changed”. A structure that had intervals in equal sevenths and not diatonic, as they are now.

## PROCEDURE FOR FINDING OUT

1. *Divide the octave into seven equal segments.*
2. *Incorporate the three separated forces.*
3. *Decipher some ancient knowledge.*

If we return to the octave of 168 and **divide it into seven equal segments**, we get the following:

### EVEN SEVENTHS

DO	336	14/7	1
TI	312	13/7	6/7
LA	288	12/7	5/7
SO	264	11/7	4/7
FA	240	10/7	3/7
MI	216	9/7	2/7
RE	192	8/7	1/7
DO	168	7/7	0

Then, by *incorporating* this “even sevenths” law of octaves *with* the **three separated forces** (see page 23), we discover that *Force-2* (224 vibrations), and *Force-3* (280 vibrations), *do not align with the structure*. *Force-1*, the force at DO (168 and 336 vibrations), is the only force that aligns with the structure. Here, “where the force and structure mutually exist” a bond is formed.

**Separated Forces / Even-Thirds  
Octave Structure / Even-Sevenths**

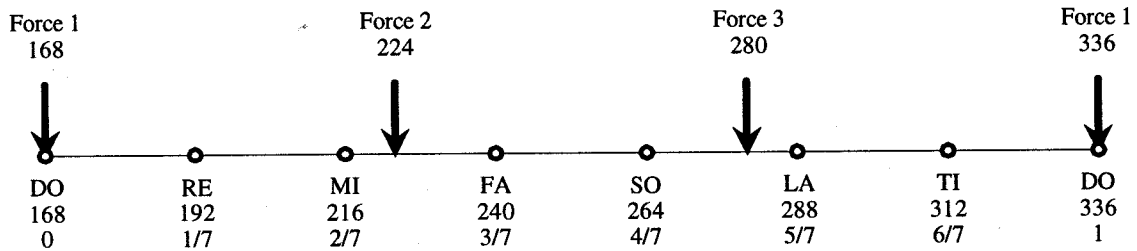

The final step, **decipher some ancient knowledge:**

“These changes in the functioning of the sacred Heptaparaparshinokh consisted in this, that in three of its Stopinders HE altered the, what are called ‘subjective actions’ which had been until then in the Stopinders, in this respect, that in one HE lengthened the law conformable successiveness; shortened it in another; and in a third, disharmonized it.

“And, namely, with the purpose of providing the ‘requisite inherency’ for receiving, for its functioning, the automatic affluence of all forces which were near, HE lengthened the Stopinder between its third and fourth deflections.

“This same Stopinder of the sacred Heptaparaparshinokh is just that one, which is still called the ‘mechano-coinciding-Mdnel-In.’” 11

The key to deciphering these passages can be found in the first paragraph where Gurdjieff says “lengthened the law conformable successiveness”. From the Absolute’s point of view (DO-336) there are seven Stopinders (DO-TI, TI-LA, LA-SO, SO-FA, FA-MI, MI-RE, and RE-DO) in law conformable [equal sevenths] succession [one after another]. To “lengthen the law conformable successiveness” implies that one of the Stopinders is going to be displaced, in this case moved away from the Absolute. Next, in the second paragraph, we find out which Stopinder is going to be moved. However, Gurdjieff “buries the dog” by: first, referring to the Stopinders in *ascending* order (DO, RE, MI, FA, SO, LA, TI, DO); and second, by telling us it is the Stopinder between the third and fourth deflections (MI-FA) that will be lengthened, *as if* the lengthening occurs between MI-FA. *Instead, it is the entire Stopinder* (the Stopinder between MI-FA) *that will undergo having its “law conformable successiveness” lengthened* (moved further away from the Absolute).

# CREATION

## Separated Forces / Even-Thirds Octave Structure / Even-Sevenths

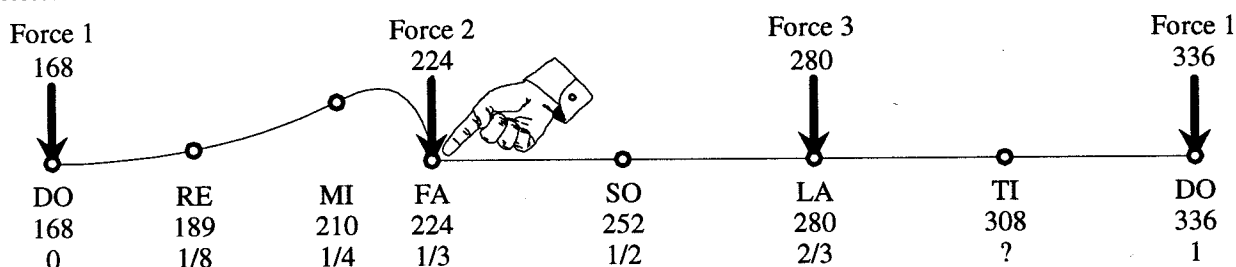
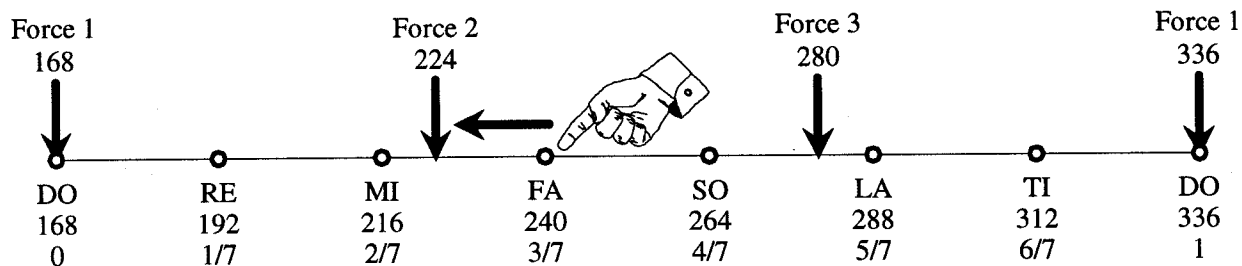

## Separated Forces / Even-Thirds Octave Structure / Diatonic Except for TI

With this interpretation, the process of creation becomes comprehensible. God, the Absolute (DO-336 vibrations), acting upon the note FA at 240 vibrations, moved the FA-MI Stopinder away from Himself until the note FA came into alignment with Force-2 at 224 vibrations. *The resulting structural alterations are truly miraculous.*

We can conceive what happened during this alignment if we envision the fabric of the Universe as a flexible, stretchable, and noncompressible fabric. The notes that were at 4/7 (264 vibrations), 5/7 (288 vibrations), and 6/7 (312 vibrations) were displaced when the Absolute moved FA from 3/7 (240 vibrations) to Force-2 at 1/3 (224 vibrations). From this same movement, the notes that were at 1/7 (192 vibrations) and 2/7 (216 vibrations) were also displaced, *flexing* this portion of the octave into what we call the “cosmic rumple”.

It is indeed quite remarkable that when FA (240 vibrations) *came into alignment* with Force-2 (224 vibrations), LA (288 vibrations) *also came into alignment* with Force-3 (280 vibrations). With this one movement, FA (240 vibrations) juxtaposed with Force-2 (224 vibrations) **the Absolute altered the entire structure of the Law of Seven and achieved common alignment with all three separated forces.** Amazingly, the new position of each note, except for TI,

is in *exact correspondence* to the diatonic scale, or rather we should say, “**created the diatonic scale**”. Now we will examine how TI became diatonic, i.e., when the Absolute shortened “the law conformable successiveness” of the last Stopinder.

“And the Stopinder which HE shortened, is between its last deflection and the beginning of a new cycle of its completing process; by this same shortening, for the purpose of facilitating the commencement of a new cycle of its completing process, HE predetermined the functioning of the given Stopinder to be dependent only upon the affluence of forces, obtained from outside through that Stopinder from the results of the action of that cosmic concentration itself in which the completing process of this primordial fundamental sacred law flows.

“And this Stopinder of the sacred Heptaparaparshinokh is just that one, which is still called the ‘intentionally-actualized-Mdnel-In.’”<sup>12</sup>

This infers that the Absolute moved the note TI closer to Himself, thus shortening “the law conformable successiveness” of the last Stopinder, TI-DO. (Note: During this shortening, the other notes in the octave were not disturbed because LA, the closest note that could have been displaced, *had previously bonded to the Force* at 280 vibrations.) We will surmise that TI was moved from 308 vibrations, past its original position of 312 vibrations, to 315 vibrations--its

**Separated Forces / Even-Thirds  
Octave Structure / Diatonic Except for TI**

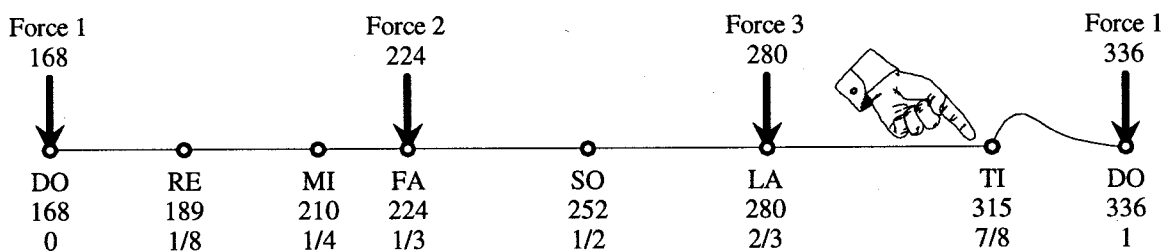
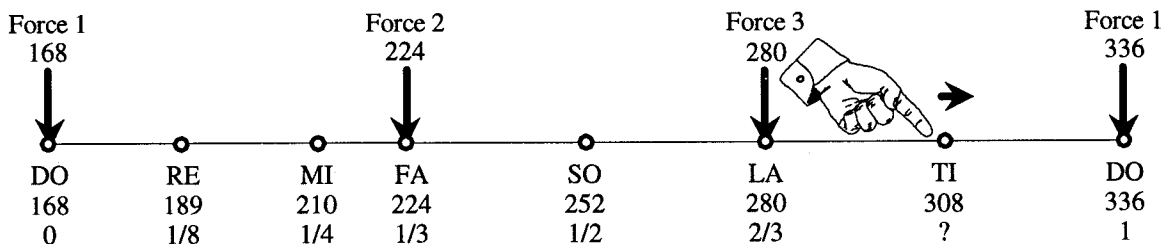

**Separated Forces / Even-Thirds  
Octave Structure / Diatonic**

present diatonic location in the octave; why TI was positioned at 315 vibrations--(7/8), and how this Stopinder *facilitates the commencement of a new cycle of the completing process*, will be discussed later. For now, you must clearly understand that the final result of making these movements--lengthening "the law conformable successiveness" of FA-MI and shortening "the law conformable successiveness" of TI-DO--**BROUGHT THE STRUCTURE OF THE OCTAVE INTO ALIGNMENT WITH THE SEPARATED FORCES, CREATED THE DIATONIC RATIOS, AND GAVE BIRTH TO THE UNIVERSE!**

Here, we shall add that *it is possible* with a thorough understanding of these laws to become harmonious with them; to establish in oneself a mental codification predicated on the different inner tastes of these tonalities that includes a particular organized way of being able to perceive cognitively and respond impartially.

Now, let us examine the correlation between the *displacement of each note* and its *diatonic position in the octave*. **Before creation**, the octave existed with all three forces at each place and since every note enjoyed the totality of all three forces, **a wholeness was present at every note**.

#### WHOLENESS BETWEEN EACH NOTE

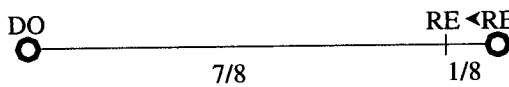
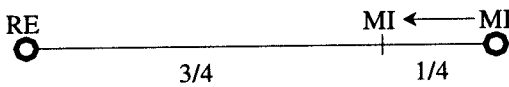
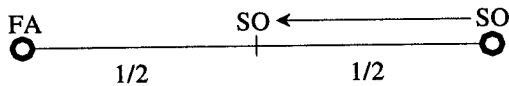
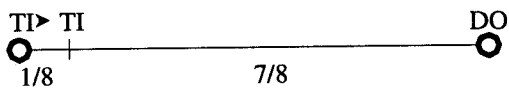

The wholeness filled the interval between the notes until the sounding of the next note, which also had "for itself" all three forces present--its own wholeness--and so on. **After creation**, when the three forces were separated, "the wholeness", which required the presence of all three forces, **was encapsulated in the totality of the octave**. Here, the three forces could no longer unite at each note but required the unification of an entire octave.

First, we will need to investigate the displacement ratios that occur within the "wholeness between the notes" (pages 24 and 25). When the notes were displaced, "the wholeness" was split in two segments. The segments reveal a ratio created by the incursion--of the displaced notes--into the

"wholeness between the notes". Note: There is no LA-TI Stopinder in the diagram because at the completion of creation, **no incursion befell the LA-TI Stopinder;**

that is, the note LA was displaced “down” into the wholeness LA-SO (page 24), and the note TI was displaced “up” into the wholeness TI-DO (page 25).

Second, let us compare: the displacement of the notes in the wholeness between the notes (left); with the location of the notes in the diatonic scale (right).

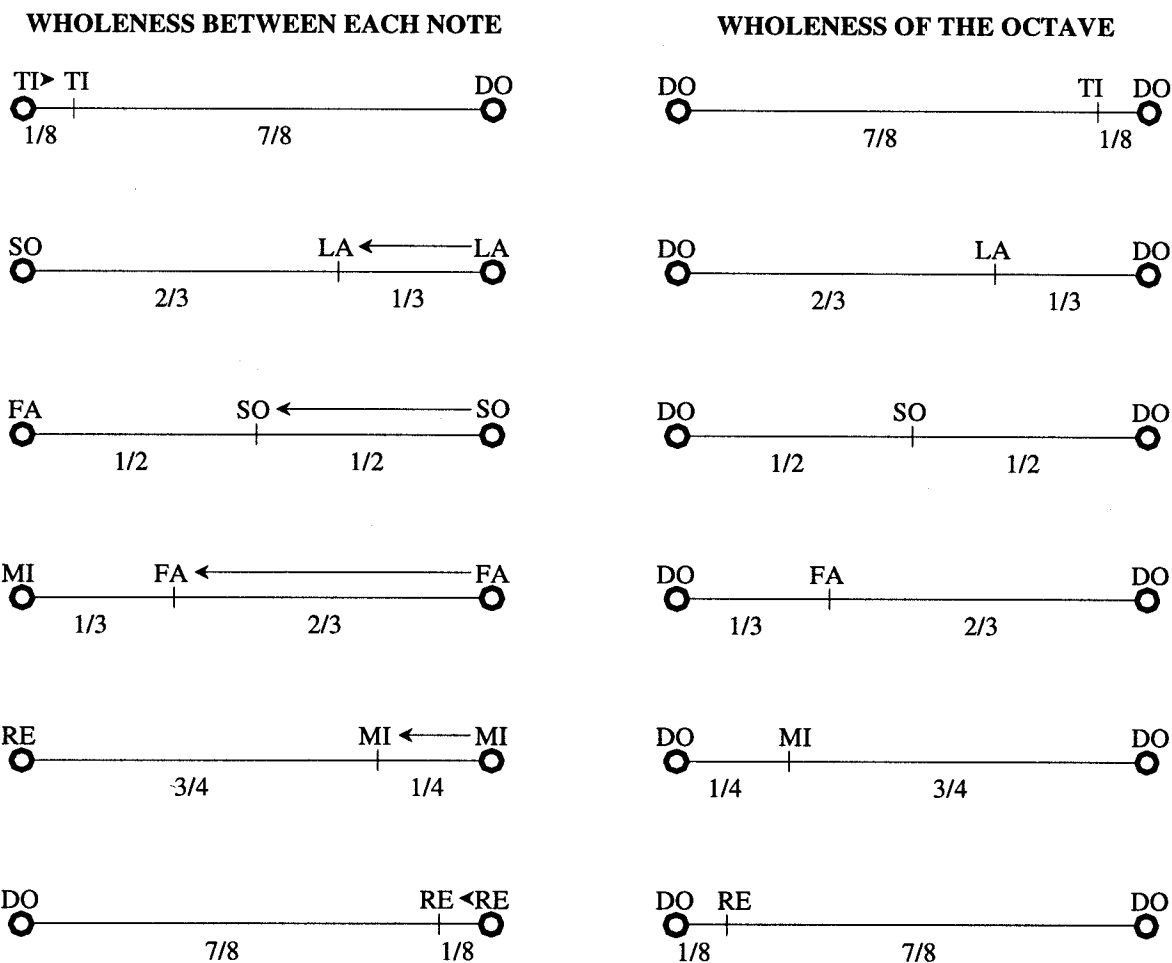

Notice that FA, SO, and LA are mathematically the same in each wholeness while RE, MI, and TI are mathematical mirror images.

Indeed, it is quite remarkable that the diatonic ratios reflect, either directly or indirectly, “the precise amount of displacement” that was incurred by each note during the changing of the Law of Seven.

**IT IS AS IF...HOW MUCH THEY MOVED  
BECAME WHAT THEY ARE!**

In addition, the ratio of the change in cosmic rumple is 9 to 7--what was 72 in length became 56 in length. This ratio also reflects what happened during the changing of the Law of Seven; that is, something *which had become 9*...was changed into something *which had to become 7*.

PRE-CREATION	POST-CREATION
1 DO • FORCE	1 DO • FORCE
2 TI •	2 TI •
3 LA •	
4 • FORCE	3 LA • FORCE
5 SO •	4 SO •
6 FA •	
7 • FORCE	5 FA • FORCE
8 MI •	6 MI •
9 RE •	7 RE •
9	7
BECAME	

# That does it!

**BY SUCCESSFULLY *UNCREATING* THE UNIVERSE, WE HAVE TAKEN  
THE FIRST STEP TOWARDS ANSWERING THE QUESTION:**

**“Why are things the way they are”?**

## REFLECTIONS

It was in 1988, after several years of directed effort towards the practical application of Gurdjieff’s teaching when, during one of my many investigations into the laws of World-creation and World-maintenance, this idea of *uncreating* the Universe first began to coagulate in the fabric of my thoughts.

Before I explain the events that followed, perhaps it would be beneficial to back up for a moment. This facet of my quest, to unlock the secrets buried in Gurdjieff's cosmology, actually began in 1980. I can still remember my first discovery. I was browsing through the dictionary and happened upon the *Geologic Time Scale*. In it, I envisioned octaves emerging...even assigning values to these octaves and calculating my own scale of geologic time. To my surprise the calculations precisely matched more than half of the dictionary's figures and the rest were close enough to convince me that indeed, there must be, behind all Life, a definable and verifiable structure...**the infrastructure of the Universe!**

From that moment on, I began to calculate octaves of every imaginable size, in hopes that I would recognize other patterns emerging. All the while, I kept reading and re-reading Gurdjieff's writings, in order to learn more about myself and to look for additional clues that might aid me in this quest. With perseverance I was able to unscramble other indications that also pointed in the same direction--the octave's inner structure (chapter three), an octave's duality (chapter four), the diatonic enneagram and shock octaves (chapter five)--which, of course, further stimulated my search.

*It seemed as if the complexities of Gurdjieff's two Fundamental Laws were unfolding before my eyes.* I should have been elated but instead I was filled with trepidation for I knew that until I was able to understand their creation and actually verify how and why these Laws acquired such a "specific structure", all of my efforts would remain speculation, a manipulation of facts and figures; that is, results without substance. Then, on that fate filled day in 1988, after eight years of searching, and after I had calculated enough material to literally fill a small library, *the idea finally hit me!* If I could unravel the "diatonic" law of octaves, and then recreate it, I would then have absolute confidence in the ensuing structure, and also unequivocally substantiate my previous findings.

Days passed without sleep. I could not stop the momentum that had begun, nor did I want to. Finally, the vivifying process completed itself. I excitedly constructed the first working model revealing the changing of the Laws, then demonstrated to several students the creation of the diatonic scale, and ultimately, the actualization of the Universe itself. Needless to say, they became very quiet..."contemplating its possibilities"; and very active..."applying its realities". Perhaps, you will too. So, let us now return to our investigations, where we will discover "together", the law conformable results which flow forth from that moment when the **Diatonic Universe** and everything in it came into being.

## CHAPTER TWO PROJECT

Construct a model showing the creation of the Universe.

You will need:      Poster board  
                             Ruler  
                             Elastic strip--1/2" wide, 12-1/2" long  
                             Paper strip--1/2" wide, 9-1/2" long  
                             Stapler  
                             Tape

To create the diatonic scale, take a poster board, drop down 1" and mark a vertical line 21" long and 1/4" to the left of center. Divide the line into seven 3" segments (8 points). To the left of the line label the points **DO, TI, LA, SO, FA, MI, RE, and DO**, from the top down. Mark the line again in 1/8" segments; thus making the ascending **DO-0, RE-24 (1/7), MI-48 (2/7), FA-72 (3/7), SO-96 (4/7), LA-120 (5/7), TI-144 (6/7)**, and the descending **DO-168 (7/7)** [see finished diagram on page 31].

Next, divide the line into three equal segments to identify the three separated forces. Draw the force lines at 0, 7", 14" and 21", or in 1/8" increments at 0, 56, 112, and 168 on the scale.

At this point, drop down 1" and draw another 21" vertical line, but this time draw it 1/4" to the right of center, keeping parallel with the other 21" line. Using the same scale of 1/8", label this line diatonically. Thus, making the ascending **DO-0, RE-21 (1/8), MI-42 (1/4), FA-56 (1/3), SO-84 (1/2), LA-112 (2/3), TI-147 (7/8)**, and the descending **DO-168 (1)**.

To complete the model, take a 1/2" wide, 12-1/2" long elastic strip, and staple it, at and even with the descending **DO's** leaving 1/2" above the **DO's**, in which to put the staples (put one staple at 168, even with the descending **DO's**). Note: The bottom of the elastic should fall even with the **FA** of the left line at 72, exactly 12" from the descending **DO**.

Also, cut a 1/2" wide strip of typing paper 9-1/2" long. Tape it between the two lines, but this time, at and even with the ascending **DO's** leaving 1/2" below the ascending **DO's** on which to put the tape, and 9" above. Note: The top end of the 1/2" paper strip should meet exactly with the bottom end of the 1/2" elastic strip--at 72 on the scale.

3/3 FORCE — 7/7 DO 168 —————> 168 DO 1 — FORCE —>

6/7 TI 144 —————> 147 TI 7/8

5/7 LA 120 —————> 112 LA 2/3 — FORCE —>

2/3 FORCE —————> 112 LA 2/3 — FORCE —>

4/7 SO 96 —————> 84 SO 1/2

3/7 FA 72 —————> 56 FA 1/3 — FORCE —>

1/3 FORCE —————> 56 FA 1/3 — FORCE —>

2/7 MI 48 —————> 42 MI 1/4

1/7 RE 24 —————> 21 RE 1/8

0

0 DO 0 —————> 0 DO 0

Finally, mark the center strips the same as the left line. The elastic should now be marked with lines representing descending **DO**-(7/7), **TI**-(6/7), **LA**-(5/7), **SO**-(4/7), and **FA**-(3/7). The paper strip should be marked with lines representing **FA**-(3/7), **MI**-(2/7), **RE**-(1/7), and ascending **DO**-(0). The bottom of the elastic strip and the top of the paper strip are marked **FA**-(3/7) since they meet at this point.

To observe the shifting of the notes, simply stretch the **FA**-(3/7)--72, at the end of the elastic, down to the force line at (1/3)--56. You will discover that the lines on the elastic strip have moved, and now align with the diatonic scale (except for **TI**, which is diatonically positioned by the shortening of the last Stopinder). Likewise, if you push the top end of the paper strip down to the force line at (1/3) 56, you will produce a close facsimile of the *cosmic rumple*. It identifies that the resulting new positions of **MI** and **RE** are also in perfect alignment with the diatonic scale, by virtue of a perpendicular line drawn back to the plane of the poster board.

# CREATION

## Separated Forces / Even-Thirds Octave Structure / Even-Sevenths

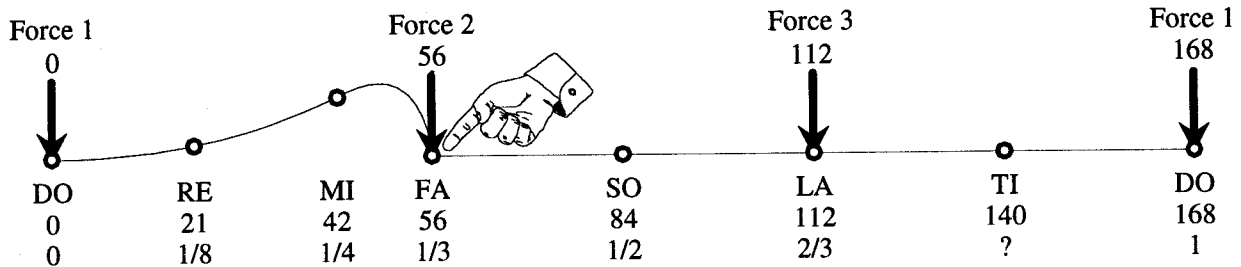
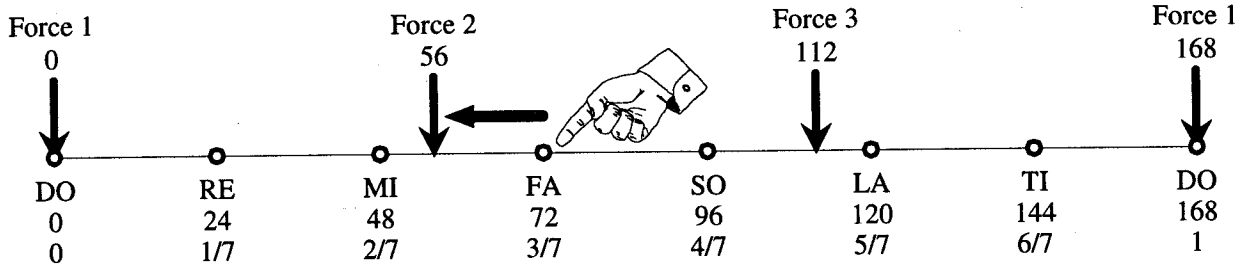

## Separated Forces / Even-Thirds Octave Structure / Diatonic Except for TI

To observe the shortening of the last Stopinder, hold LA in place at 112 vibrations and move TI to 147 vibrations. A small version of the cosmic rumple will appear between the TI-DO interval.

## CREATION PART TWO

### Separated Forces / Even-Thirds Octave Structure / Even-Sevenths

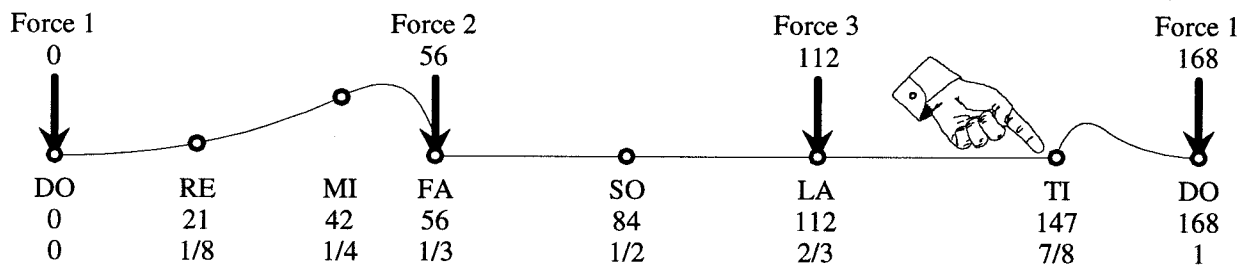
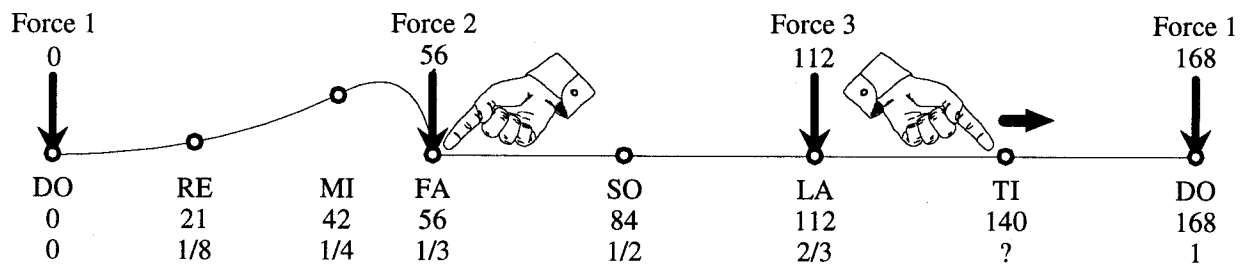
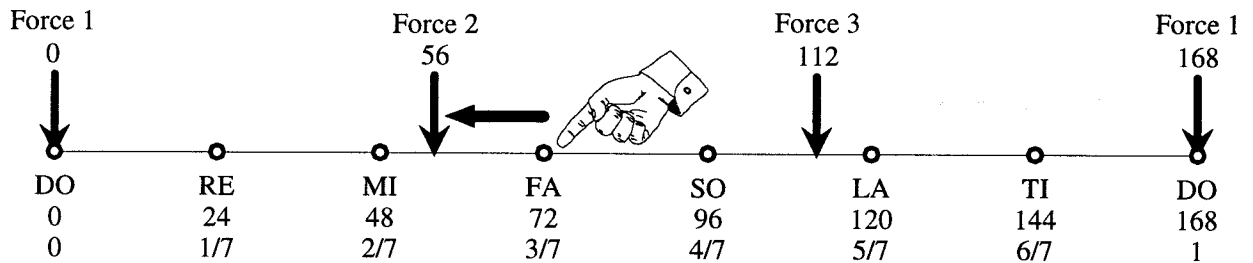

### Separated Forces / Even-Thirds Octave Structure / Diatonic

**MI**

## CHAPTER THREE

# INFRASTRUCTURAL COGNIZANCE

Continuing our investigation to uncover the “dogs” buried in Gurdjieff’s cosmology we shall now analyze what Gurdjieff described as “three octaves of radiations”.

“In order to study these radiations let us take the ‘ray of creation’ in an abridged form: Absolute-sun-earth-moon, or in other words let us imagine the ‘ray of creation’ in the form of *three octaves of radiations*: the first octave between the Absolute and the sun, the second octave between the sun and the earth, and the third octave between the earth and the moon; and let us examine the passage of radiations between these four fundamental points of the universe.

**“We have to find our place and understand our functions in this universe, which is taken in the form of *three octaves of radiations* between four points.”** <sup>13</sup>

### RAY OF CREATION

DO ABSOLUTE •  
TI All Worlds  
LA All Suns  
SO Sun •  
FA All Planets  
MI Earth •  
RE Moon •  
DO ABSOLUTE

FOUR FUNDAMENTAL POINTS  
THREE OCTAVES

Gurdjieff goes on to explain “twelve classifications of matter” that are revealed by this structure. They are fairly easy to comprehend, but the “dog” Gurdjieff intended for us to exhume can be exposed if we look at the *mathematics* of the four fundamental points. We will then understand why three octaves of radiations [*or three inner octaves*] come into existence.

The diatonic octave from 48 to 24 hides a very cleverly concealed canine.  
 Tip: A mathematical *inner halving* of vibrations occurs at four fundamental points.

### OCTAVE OF 48 TO 24

48	DO	ABSOLUTE	•48	
45	TI	All Worlds		
40	LA	All Suns		FOUR FUNDAMENTAL POINTS
36	SO	Sun	•36	THREE OCTAVES
32	FA	All Planets		
30	MI	Earth	•30	
27	RE	Moon	•27	
24	DO	ABSOLUTE		

**AN EMBEDDED DOG APPEARS WHEN WE EXAMINE THE OCTAVE AS  
 A TOTALITY; THAT IS, FROM ITS "ALLNESS TO ITS NOTHINGNESS".**

### TOTALITY OF 24

24	DO	ABSOLUTE	•24	
21	TI	All Worlds		
16	LA	All Suns		FOUR FUNDAMENTAL POINTS
12	SO	Sun	•12	THREE OCTAVES
8	FA	All Planets		
6	MI	Earth	• 6	
3	RE	Moon	• 3	
0	DO	ABSOLUTE		

The four fundamental points in the totality of an octave--Do, So, Mi, and Re--mathematically exist, exactly, where a doubling or halving of inner vibrations *naturally* occurs. Remember, any whole phenomenon can be calculated as an octave, as a "something" that runs from its allness to its nothingness, or vice versa, dividing the totality "diatonically" by the ratios: 1/8, 1/4, 1/3, 1/2, 2/3, and 7/8. The notes **DO**, **SO**, **MI**, and **RE** at 1, 1/2, 1/4, and 1/8 respectively, are precisely, where this doubling or halving in the diatonic ratios occurs. The result is that their own mathematical existence, intrinsically, creates "*three inner octaves*"!

If an octave's four fundamental points divide it into *three inner octaves*, then each of these *three inner octaves* must also be divided--by virtue of its own

four fundamental points--into an additional *three inner octaves*, and so forth. The resulting **inner structure**, will allow us to study Man and the Universe with remarkable precision.

To begin, we must first calculate an octave from its allness to its nothingness; and then, calculate the *three inner octaves* that come into existence between the octave's four fundamental points. Note: We shall use the octave of 192 vibrations as our totality since 192 is the smallest totality that allows all *three inner octaves* to calculate as whole numbers.

For identification, we shall call the totality of 192, 192 to 0, (scale-0); and the three inner octaves, 192 to 96, 96 to 48, and 48 to 24, (scale-1). Scale-1 is *mathematically correct*; that is, it reflects the actual doubling or halving of an octave's vibrations. Scale-0 reflects the *totality*; i.e., from all to nothing.

Our first observation should be directed upon the vibrations from scale-0 to see if they reappear as vibrations in scale-1. As we examine the fate of the vibrations from scale-0, we find that 192 (the allness or descending **DO** in scale-0), the first fundamental point, becomes a descending DO in scale-1.

168 (the **TI** in scale-0) is not found in scale-1, and we are left wondering about it...but we shall return to it later.

128 (the **LA** in scale-0) is a FA in scale-1.

96 (the **SO** in scale-0)--the second of the four fundamental points--becomes, in scale-1, what we call an "oscillating DO" (ascending & descending).

64 (the **FA** in scale-0) is a FA in scale-1.

48 (the **MI** in scale-0)--the third fundamental point--becomes an oscillating DO in scale-1.

Note: The vibration at **SO** and the vibration at **MI** each uniquely becomes an oscillating DO in scale-1 [we shall explore the importance of this discovery in the next chapter].

24 (the **RE** in scale-0)--the fourth fundamental point--is an ascending DO in scale-1 and, thereupon, *is the bottom for all of scale-1* [the significance of Re becoming the bottom of the next inner scale will be discussed in chapter seven].

Scale-0		Scale-1	
<b>DO</b>	192	DO	192
		TI	180
<b>TI</b>	168		
		LA	160
			144
<b>LA</b>	128	FA	128
		MI	120
		RE	108
<b>SO</b>	96	DO	96
		TI	90
		LA	80
		SO	72
<b>FA</b>	64	FA	64
		MI	60
		RE	54
<b>MI</b>	48	DO	48
		TI	45
		LA	40
		SO	36
		FA	32
		MI	30
		RE	27
<b>RE</b>	24	DO	24
<b>DO</b>	0		

Finally, the vibration 0 (the ascending **DO** in scale-0) according to the structure of the three octaves of radiations is--by definition--not a part of scale-1, and in relation to inner octaves...disappears forever.

Scale-0 has a single octave; this single octave has eight vibrations, seven Stopinders, or six vibrations between its beginning and ending **DO**'s. Therefore, scale-0 reflects things in totalities of six, seven, or eight. Six reflects what is between its point of origin and its point of termination. Seven reflects the seven segments of its wholeness. Eight reflects the totality including the beginning and ending **DO**'s.

Scale-1 has three octaves. These three octaves have twenty-two vibrations, or twenty-one Stopinders; or eighteen vibrations created between the four fundamental points from scale-0. Manifestations in the universe that reveal totalities of eighteen, twenty-one, or twenty-two are most likely reflections of this scale.

Together, scale-0 and scale-1 have a total of four octaves and twenty-four vibrations. These four octaves each have a different length:

### OCTAVE LENGTHS

1 length of 192 vibrations:	192 to 0
1 length of 96 vibrations:	192 to 96
1 length of 48 vibrations:	96 to 48
1 length of 24 vibrations:	48 to 24

We have defined the fate of the vibrations from scale-0, and the structure of both scale-0 and scale-1 octaves. However, as previously discussed, inner octaves do not stop at scale-1. Each scale-1 octave has its own set of four fundamental points; therefore, its own set of three inner octaves. This next inner scale of octaves we shall call scale-2 (see page 39).

In computing the corresponding ratios of  $1/8$ ,  $1/4$ ,  $1/3$ ,  $1/2$ ,  $2/3$ , and  $7/8$  for the nine scale-2 octaves we will use the totality of 1536 for the scale-0 octave, as it allows us to calculate the diatonic ratios of all three scales at whole numbers.

Remember, only scale-1 octaves are *mathematically correct*. To calculate scale-2, *all nine scale-2 octaves must be "individually" configured as a totality*. Then, the diatonic ratios of each totality ( $1/8$ ,  $1/4$ ,  $1/3$ ,  $1/2$ ,  $2/3$ , and  $7/8$ ) are added to its ascending Do. For example: an octave is born in scale-2 (between 1536 and 1152) because DO-1536 and SO-1152 are fundamental points in scale-1--the descending Do is at 1536, the ascending Do is at 1152, and its totality is 384.

Totality	Factor	Result	↑ DO	Answer	Note
384	x 1	= 384	+ 1152	= 1536	Do
384	x 7/8	= 336	+ 1152	= 1488	Ti
384	x 2/3	= 256	+ 1152	= 1408	La
384	x 1/2	= 192	+ 1152	= 1344	So
384	x 1/3	= 128	+ 1152	= 1280	Fa
384	x 1/4	= 96	+ 1152	= 1248	Mi
384	x 1/8	= 48	+ 1152	= 1200	Re

## SCALE-2 OBSERVATIONS

Earlier we discovered which vibrations from scale-0 *reappeared* as vibrations in scale-1. Now, after computing all vibrations in scale-2, we find *the vibrations in scale-1, similarly, reappear as vibrations in scale-2*: (Descending DO-1536 is descending Do-1536); (TI's are still in doubt); (LA's are Fa's); (SO's and MI's become oscillating Do's); (FA's are Fa's); (RE's become ascending Do's); (and ascending DO-192...disappears).

Note: DO-768 and DO-384, the oscillating DO's in scale-1, **are unique** and only become descending Do's in scale-2, that is, *an oscillating Do has its descending aspect continue, and its ascending aspect disappear*. RE-864 and 432 in scale-1 become ascending Do's (864 and 432) in scale-2 and replace the two, disappearing ascending DO's (768 and 384) from scale-1. As a result, **a pause occurs "twice" in scale-2**: between (Do-384 to Do-432), and between (Do-768 to Do-864).

These **adjacent Do's** in scale-2, what we call the "double Do's", **are pauses in scale-2** between *three sets of three consecutive octaves*: (three octaves, 22 consecutive diatonic vibrations)-- followed by a **pause**; then, there is another set of (three octaves, 22 consecutive diatonic vibrations)-- followed by **another pause**; finally, a third set of (three octaves, 22 consecutive diatonic vibrations).

Scale-0		Scale-1		Scale-2	
1536	DO	1536	DO	1536	Do
				1488	Ti
		1440	TI		
				1408	La
1344	TI			1344	So
		1280	LA	1280	Fa
				1248	Mi
				1200	Re
		1152	SO	1152	Do
				1128	Ti
				1088	La
				1056	So
1024	LA	1024	FA	1024	Fa
				1008	Mi
				984	Re
		960	MI	960	Do
				948	Ti
				928	La
				912	So
				896	Fa
				888	Mi
				876	Re
		864	RE	864	Do
768	SO	768	DO	768	Do
				744	Ti
		720	TI		
				704	La
				672	So
		640	LA	640	Fa
				624	Mi
				600	Re
		576	SO	576	Do
				564	Ti
				544	La
				528	So
512	FA	512	FA	512	Fa
				504	Mi
				492	Re
		480	MI	480	Do
				474	Ti
				464	La
				456	So
				448	Fa
				444	Mi
				438	Re
		432	RE	432	Do
384	MI	384	DO	384	Do
				372	Ti
		360	TI		
				352	La
				336	So
		320	LA	320	Fa
				312	Mi
				300	Re
		288	SO	288	Do
				282	Ti
				272	La
				264	So
		256	FA	256	Fa
				252	Mi
				246	Re
		240	MI	240	Do
				237	Ti
				232	La
				228	So
				224	Fa
				222	Mi
				219	Re
		216	RE	216	Do
192	RE	192	DO		
0	DO				

Together, all three scales (thirteen octaves with seven lengths) total: eighty notes (counting the all and nothing **DO**'s separately), seventy-nine notes (counting the all and nothing **DO**'s together), or seventy-eight notes (counting what is between the all and nothing **DO**'s). These eighty, seventy-nine, or seventy-eight *notes* occupy only seventy-one, seventy, or sixty-nine *vibrations*. This is because *seven vibrations* are shared by *sixteen notes*; for example, three notes are at the vibration 1024 (see page 41). This one vibration represents three notes.

### **THREE SCALES, THIRTEEN OCTAVES, SEVENTY-ONE VIBRATIONS**

This same structure (three scales, thirteen octaves, seventy-one vibrations) is also fabricated in the process of defining "what a thing is". In other words, **to know what something is, we must know it on all scales--*what is before it; what is beyond it; what its parts are; and what it is a part of.*** As an example, we will define the octave of 384 vibrations (384 vibrations to 768 vibrations).

DO	768	
TI	720	
LA	640	
SO	576	<b>THE OCTAVE OF 384 VIBRATIONS</b>
FA	512	
MI	480	
RE	432	
DO	384	

Next, we add the octaves *Before* and *Beyond* the octave of 384 vibrations:

DO	1536	
TI	1440	
LA	1280	<b>768,</b>
SO	1152	<b>THE OCTAVE</b>
FA	1024	<b>BEYOND IT</b>
MI	960	
RE	864	
DO	768	
TI	720	
LA	640	
SO	576	<b>THE OCTAVE OF 384 VIBRATIONS</b>
FA	512	
MI	480	
RE	432	
DO	384	
TI	360	
LA	320	<b>192,</b>
SO	288	<b>THE OCTAVE</b>
FA	256	<b>BEFORE IT</b>
MI	240	
RE	216	
DO	192	

LARGER	← ORIGINAL		SMALLER
DO 1536	DO 1536	THE	DO 1536
	TI 1440		TI 1488
TI 1344	LA 1280		LA 1408
	SO 1152		SO 1344
	FA 1024	OCTAVE	FA 1280
LA 1024	MI 960		MI 1248
	RE 864		RE 1200
	DO 768		DO 1152
	TI 720	BEYOND	TI 1128
SO 768	LA 640		LA 1088
	SO 576		SO 1056
	FA 512		FA 1024
	MI 480	THE	MI 1008
FA 512	RE 432		RE 984
	DO 384		DO 960
	TI 360		TI 948
	LA 320	OCTAVE	LA 928
	SO 288		SO 912
	FA 256		FA 896
	MI 240		MI 888
MI 384	RE 216	BEFORE	RE 876
	DO 192		DO 864
	TI 192		DO 768
RE 192	DO 0		TI 744

**PARTS OF  
WHAT IS  
BEYOND IT**

**PARTS OF  
THE OCTAVE**

**PARTS OF  
WHAT IS  
BEFORE IT**

Its "parts" are its own *three inner octaves*, as well as, the *three inner octaves* of the octave before it and the octave beyond it. This gives us a total of twelve octaves; three are in the original scale, and nine are in the smaller scale.

What it is all a "part of" is revealed by realizing that the four DO's in the original scale *must be the four fundamental points of a larger scale*. That larger scale is an octave from its "allness" to its "nothingness" (1536 to 0).

To define the octave of 384 we had to construct twelve other octaves (thirteen octaves in three scales); and these thirteen octaves correspond with the inner octaves that we previously called: scale-0, scale-1, and scale-2.

### TIME FOR TI

Now, let us examine what happens to the vibration at Ti. We previously identified that TI from scale-0 had no matching vibration in scale-1; but, we can now verify that the vibration 1344 (the TI in scale-0) reappears at So-1344 in scale-2. Afterwards, the vibration 1344 at So becomes, in scale-3, an oscillating do. Thus, the vibration at "any note Ti" will, accordingly, *skip one scale* and then reappear *one scale removed* at the note So.

## ACCORDING TO SCALE

Continuing our search for buried dogs, we find there is something familiar about *the number of vibrations created in each scale*. This needs more exhumation...so we will keep digging!

In scale-2 we had a total of sixty-six vibrations (fifty-four vibrations created by twelve Do's). *The fifty-four vibrations represent scale-2* since the twelve Do's in scale-2 previously came into existence as fundamental points in scale-1.

In scale-1 we had a total of twenty-two vibrations (eighteen vibrations created by four DO's). *The eighteen vibrations represent scale-1* since the four DO's in scale-1 previously came into existence as fundamental points in scale-0.

In scale-0 we had a total of eight vibrations (six vibrations created by the all and nothing DO's). *The six vibrations represent scale-0* since the all and nothing DO's, correspondingly, must have also come into existence in a previous scale [this unknown scale will be discussed later].

### NOTES CREATED IN EACH SCALE:

- 2 notes are created in Scale-?
- 6 notes are created in Scale-0
- 18 notes are created in Scale-1
- 54 notes are created in Scale-2

This inherent *inner structure* in the octave: four fundamental points, three inner octaves, and subsequent inner-inner octaves--is principal to our understanding the infrastructure of the universe; therefore, we should expand our analysis of this multi-scaled structure. This can be accomplished by postulating several questions...then analyzing the ensuing answers.

Scale-0		Scale-1		Scale-2	
1536	DO	1536	DO	1536	Do
				1488	Ti
		1440	TI		
				1408	La
1344	TI			1344	So
		1280	LA	1280	Fa
				1248	Mi
				1200	Re
		1152	SO	1152	Do
				1128	Ti
				1088	La
				1056	So
1024	LA	1024	FA	1024	Fa
				1008	Mi
				984	Re
		960	MI	960	Do
				948	Ti
				928	La
				912	So
				896	Fa
				888	Mi
				876	Re
		864	RE	864	Do
768	SO	768	DO	768	Do
				744	Ti
		720	TI		
				704	La
				672	So
		640	LA	640	Fa
				624	Mi
				600	Re
		576	SO	576	Do
				564	Ti
				544	La
				528	So
512	FA	512	FA	512	Fa
				504	Mi
				492	Re
		480	MI	480	Do
				474	Ti
				464	La
				456	So
				448	Fa
				444	Mi
				438	Re
		432	RE	432	Do
384	MI	384	DO	384	Do
				372	Ti
		360	TI		
				352	La
				336	So
		320	LA	320	Fa
				312	Mi
				300	Re
		288	SO	288	Do
				282	Ti
				272	La
				264	So
		256	FA	256	Fa
				252	Mi
				246	Re
		240	MI	240	Do
				237	Ti
				232	La
				228	So
				224	Fa
				222	Mi
				219	Re
		216	RE	216	Do
192	RE	192	DO		
0	DO				

## PLAYING WITH A FULL DECK

How many cards in a standard deck of playing cards--including the Jokers?

Answer: fifty-four.

How many vibrations were created in scale-2?

Answer: fifty-four!

If we eliminate the largest similar series of cards, the thirty-six numbered cards--two through ten in four suits--how many cards are left?

Answer: eighteen.

How many vibrations were created in scale-1?

Answer: eighteen!

If we eliminate the next largest similar series of cards, the twelve face cards--Jack, Queen, and King in four suits--how many cards are left?

Answer: six.

How many vibrations were created in scale-0?

Answer: six!

If we eliminate the next largest similar series, the four Aces, how many cards are left?

Answer: two.

How many vibrations were represented from an unknown scale?

Answer: two!

Fifty-four cards in a deck minus the thirty-six numbered cards equal eighteen, minus the twelve face cards equal six, minus the four Aces equal two.

It is of major importance to understand why the deck of cards was designed. Obviously, long ago, *someone understood the structure of the thirteen octaves* and designed the cards in order to preserve the knowledge of this remarkable structure.

*Someone understood that the fifty-four vibrations created in scale-2 could be represented by the fifty-four cards in the deck.*

*Someone understood that the eighteen vibrations created in scale-1 could be represented by eliminating the thirty-six numbered cards.*

*Someone understood that the six vibrations created in scale-0 could be represented by eliminating the twelve face cards.*

*Someone understood that the two vibrations from the unknown scale could be represented by eliminating the four Aces.*

In addition, we can surmise that even the designs on the cards were carefully planned to indicate **that certain groups of cards** would be used in more than one scale. The fifty-four cards in the deck are divided into four groups: **Numbered cards, Face cards, Aces, and Jokers.**

**Numbered cards** incorporate a matching number of individual “pips” that correspond to the numbers on the cards; a pip is the symbol of either a Diamond, Club, Heart, or Spade. The **individual pips** indicate that numbered cards will be used in **one scale**. *The numbered cards are only found in scale-2* (see page 45).

**Face cards** have pictures. The pictures feature a double image of the Jack, Queen, or King. This **double image** indicates that face cards are to be used in **two scales**. *The face cards are used twice; they are in scale-1 and scale-2.*

**Aces** are both “similar to yet different from” numbered cards and face cards. The Aces are similar to the face cards; both have letters in the corner. The Aces are similar to the numbered cards; both have pips in the center. Aces also appear twice in the sequence: **Ace, 2, 3, 4, 5, 6, 7, 8, 9, 10, Jack, Queen, King, Ace.** The Ace is at the beginning, like the numbered cards, and at the end, like the face cards. The result of being **similar to numbered cards and face cards** gives the Aces a three-fold representation and indicates that Aces will be used in **three scales**. *The Aces appear three times; they are in scale-0, scale-1, and scale-2.*

**Jokers** usually picture something to represent the **four suits**; for example: a Joker juggling the four suits; a Joker with the four suits at the points of his hat, or around his collar; etc. This symbology indicates Jokers will be used in **four scales**. *The Jokers are found four times; they are in all three scales, and also represent the two vibrations from the unknown scale.*

Notice also that the four suits reflect a four, three, two, one symbology: Diamonds ♦ have four sides; Clubs ♣ have three sides; Hearts ♥ have two sides; and Spades ♠ can be viewed as having only one side, as being--so to say--an inverted heart with a single point unified into oneness.

## WHAT DOES ALL THIS MEAN?

Gurdjieff said, “We have to find our place and understand our functions in this Universe...”. If you recall, **Man has seven centers: sex, instinctive, moving, emotional, intellectual, higher emotional, and higher mental.** We can surmise that the deck of cards was designed to portray these seven centers.

Joker: the higher mental center  
 Extra Joker: the higher emotional center  
 Spades ♠: intellectual center  
 Hearts ♥: emotional center  
 Clubs ♣: moving center  
 Diamonds ♦: instinctive center  
 Aces: sex center  
 (we will examine this idea  
 of Aces as the sex center later  
 in this publication)

Gurdjieff's teaching further relates that each of these centers is divided into **three parts**: *mechanical*, *emotional*, and *intellectual*. Then again, each part is subdivided into **three parts-of-parts**: *mechanical*, *emotional*, and *intellectual*. Astonishingly, if we display the cards in the *diatonic, sevenfold structure* of the thirteen octaves, this inner complexity--"three parts" & "three parts-of-parts"--is revealed within the progression of scales [which is in multiples of three]: (2 x 3 = 6); (6 x 3 = 18); (18 x 3 = 54). Each vibration is represented by three vibrations in the next scale.

Another interesting observation is also revealed by displaying the cards in the "diatonic structure of inner octaves". Here we find that although the face cards are represented in two scales, the Aces in three and the Jokers in four, they always emanate on notes of a common name. Examples: *regardless of the scale they are in*, the Ace of Hearts always appears on a Fa, the Extra Joker always occurs on a La, and the Joker always turns up on a Ti.

## THE YIN AND YANG

Between the beginning and ending DO's--the Yin and Yang--come **69** vibrations that define Life from its humblest beginnings to its highest Spirituality.

Scale-?	Scale-0	Scale-1	Scale-2
JO "TI"	DO	DO	Do
			JO Ti
		JO TI	
			XJ La
	JO TI		A♠ So
		XJ LA	A♥ Fa
			A♣ Mi
			A♦ Re
		A♠ SO	Do
			K♠ Ti
			Q♠ La
			J♠ So
	XJ LA	A♥ FA	K♥ Fa
			Q♥ Mi
			J♥ Re
		A♠ MI	Do
			K♠ Ti
			Q♠ La
			J♠ So
			K♦ Fa
			Q♦ Mi
			J♦ Re
		A♦ RE	Do
	A♠ SO	DO	Do
			10♠ Ti
		K♠ TI	
			9♠ La
			8♠ So
		Q♠ LA	7♠ Fa
			6♠ Mi
			5♠ Re
		J♠ SO	Do
			4♠ Ti
			3♠ La
			2♠ So
	A♥ FA	K♥ FA	10♥ Fa
			9♥ Mi
			8♥ Re
		Q♥ MI	Do
			7♥ Ti
			6♥ La
			5♥ So
			4♥ Fa
			3♥ Mi
			2♥ Re
		J♥ RE	Do
	A♠ MI	DO	Do
			10♠ Ti
		K♠ TI	
			9♠ La
			8♠ So
		Q♠ LA	7♠ Fa
			6♠ Mi
			5♠ Re
		J♠ SO	Do
			4♠ Ti
			3♠ La
			2♠ So
		K♦ FA	10♦ Fa
			9♦ Mi
			8♦ Re
		Q♦ MI	Do
			7♦ Ti
			6♦ La
			5♦ So
			4♦ Fa
			3♦ Mi
			2♦ Re
		J♦ RE	Do
	A♦ RE	DO	
XJ "LA"		DO	

With the aid of this *structure* we can watch the creative flow of evolution from the moment *it* enters the Universe as the duplicating principle and gives birth to the instinctive center--the Ace of Diamonds.

The duplicating principle is the smallest and purest representation of the Law of Octaves that satisfies both fundamental processes of Life: that of reproduction and that of growth. Any Life--as we define it--originating in the Universe, cannot continue without it.

The Ace of Diamonds begins the instinctive life cycle by the formation of the RNA molecule. Later, as we investigate the structure of RNA, we shall see how RNA conforms precisely to the structure of the Law of Seven; how this structure allows for RNA to accomplish duplication, and how this duplication ultimately results in the formation of DNA. We must understand that with RNA and DNA--the precursors to cell division--life can begin at the Ace of Diamonds. The Ace of Diamonds represents the first order of instinctive manifestations capable of this copying process.

From there we move to the Jack of Diamonds. The Jack of Diamonds is the mechanical part of the instinctive center. Gurdjieff tells us that mechanical parts function *automatically*--without attention. In our instinctive center this would encompass almost all of our physiological processes, such as: circulation, respiration, digestion, the reproduction of cells, and so forth; which happen in us *automatically*--without any attention on our behalf as to "making" them happen.

This *automatic* instinctive part is, again, subdivided into three parts, or parts-of-parts. The three parts-of-parts of the Jack of Diamonds are the 2, 3, and 4 of Diamonds. These cards represent different gradations in complexity of this *automatic* instinctive part; for example: heartbeat and growing hair are both *automatic* instinctive functions that proceed without our attention. If we place the growing of hair in the 2 of Diamonds and the heartbeat in the 4 of Diamonds, we can begin to get an idea of the different gradations of intelligence in this *automatic* part of our instinctive center.

In the progression of the evolutionary life process the 2, 3, and 4 of Diamonds can be envisioned as the microscopic cellular beginning of plants...and the continuing complexity of instinctive development that was acquired as new RNA molecules extended the DNA molecule's instructions.

The 5, 6, and 7 of Diamonds are the mechanical, emotional, and intellectual parts-of-parts respectively, of the Queen of Diamonds, which, for the instinctive center, is its emotional part. In *The Psychology of Man's Possible Evolution* by P.

D. Ouspensky, page 110, emotional parts require attention...attention that is "attracted or held by the subject itself"; he places our five senses in this part.

Since the aim of this publication is to expose--as thoroughly as possible--the laws of World-creation and World-maintenance, we shall not continue here with this concept, but will leave it to the reader to contemplate what each card represents as it takes its place in the structure of inner octaves; and how Life--from its simplest beginnings to the creation of Man...and even beyond--comes into being.

For easy reference, two related diagrams have been reprinted on page 48; and the octave of the cards from page 45 has been enlarged on page 49 with its *three scale-1 octaves* on separate rows.

Scale-0		Scale-1		Scale-2	
7	DO	1536	DO	1536	Do
				1488	Ti
		1440	TI		
				1408	La
1344	TI			1344	So
		1280	LA	1280	Fa
				1248	Mi
				1200	Re
		1152	SO	1152	Do
				1128	Ti
				1088	La
				1056	So
1024	LA	1024	FA	1024	Fa
				1008	Mi
				984	Re
		960	MI	960	Do
				948	Ti
				928	La
				912	So
				896	Fa
				888	Mi
				876	Re
		864	RE	864	Do
768	SO	768	DO	768	Do
				744	Ti
		720	TI		
				704	La
				672	So
		640	LA	640	Fa
				624	Mi
				600	Re
		576	SO	576	Do
				564	Ti
				544	La
				528	So
512	FA	512	FA	512	Fa
				504	Mi
				492	Re
		480	MI	480	Do
				474	Ti
				464	La
				456	So
				448	Fa
				444	Mi
				438	Re
		432	RE	432	Do
384	MI	384	DO	384	Do
				372	Ti
		360	TI		
				352	La
				336	So
		320	LA	320	Fa
				312	Mi
				300	Re
		288	SO	288	Do
				282	Ti
				272	La
				264	So
		256	FA	256	Fa
				252	Mi
				246	Re
		240	MI	240	Do
				237	Ti
				232	La
				228	So
				224	Fa
				222	Mi
				219	Re
		216	RE	216	Do
192	RE	192	DO		
0	DO				

Scale-?	Scale-0	Scale-1	Scale-2
JO "TI"	DO	DO	Do
			JO Ti
		JO TI	
			XJ La
	JO TI		A♠ So
		XJ LA	A♥ Fa
			A♣ Mi
			A♦ Re
		A♠ SO	Do
			K♠ Ti
			Q♠ La
			J♠ So
	XJ LA	A♥ FA	K♥ Fa
			Q♥ Mi
			J♥ Re
		A♣ MI	Do
			K♣ Ti
			Q♣ La
			J♣ So
			K♦ Fa
			Q♦ Mi
			J♦ Re
		A♦ RE	Do
	A♠ SO	DO	Do
			10♠ Ti
		K♠ TI	
			9♠ La
			8♠ So
		Q♠ LA	7♠ Fa
			6♠ Mi
			5♠ Re
		J♠ SO	Do
			4♠ Ti
			3♠ La
			2♠ So
	A♥ FA	K♥ FA	10♥ Fa
			9♥ Mi
			8♥ Re
		Q♥ MI	Do
			7♥ Ti
			6♥ La
			5♥ So
			4♥ Fa
			3♥ Mi
			2♥ Re
		J♥ RE	Do
	A♣ MI	DO	Do
			10♣ Ti
		K♣ TI	
			9♣ La
			8♣ So
		Q♣ LA	7♣ Fa
			6♣ Mi
			5♣ Re
		J♣ SO	Do
			4♣ Ti
			3♣ La
			2♣ So
		K♦ FA	10♦ Fa
			9♦ Mi
			8♦ Re
		Q♦ MI	Do
			7♦ Ti
			6♦ La
			5♦ So
			4♦ Fa
			3♦ Mi
			2♦ Re
		J♦ RE	Do
	A♦ RE	DO	
XJ "LA"	DO		

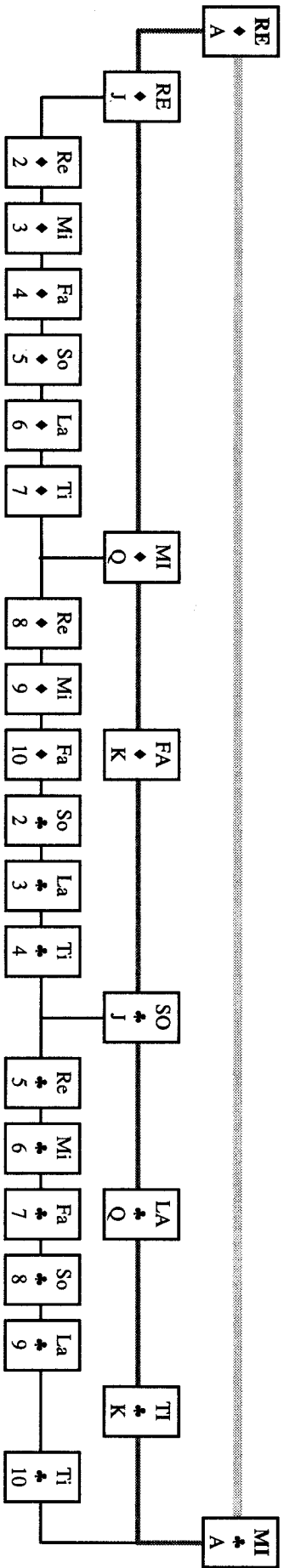
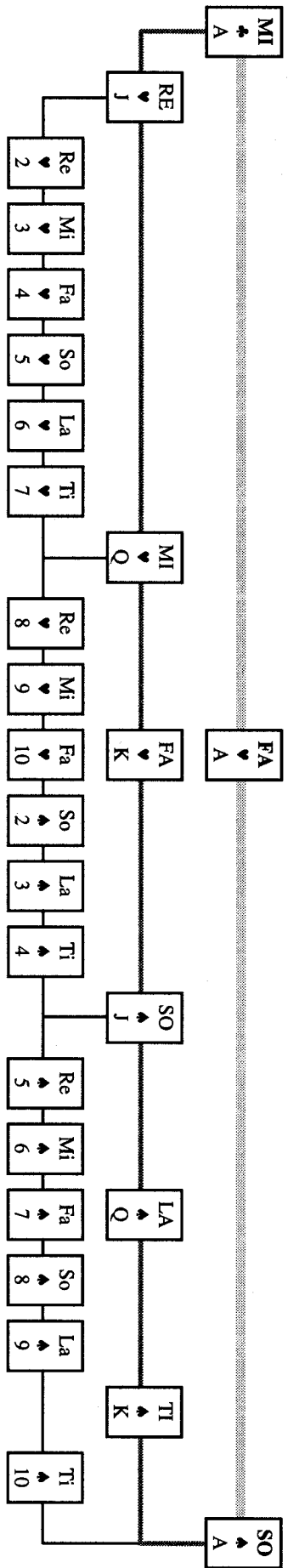
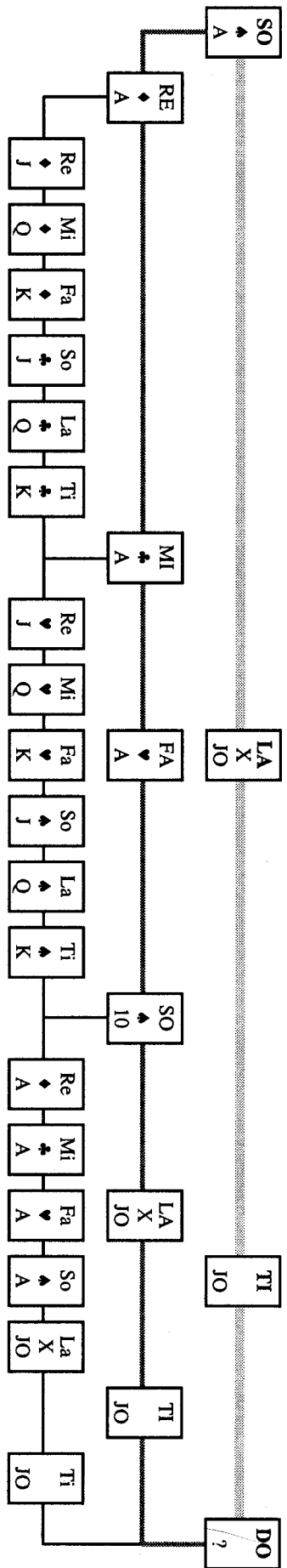

# CHAPTER THREE WORKSHEET

1. Calculate three scales of the totality of 2304. ⇒

2. Calculate two scales of the totality of 288. ↓

<b>DO</b>	288	<b>DO</b>	288
		TI	
<b>TI</b>			
		LA	
		SO	
<b>LA</b>		FA	
		MI	
		RE	
<b>SO</b>		DO	
		TI	
		LA	
		SO	
<b>FA</b>		FA	
		MI	
		RE	
<b>MI</b>		DO	
		TI	
		LA	
		SO	
		FA	
		MI	
		RE	
<b>RE</b>		DO	
<b>DO</b>			

<b>DO</b>	2304	<b>DO</b>	2304	<b>Do</b>	2304
		TI		Ti	
				La	
<b>TI</b>				So	
		LA		Fa	
				Mi	
				Re	
		SO		Do	
				Ti	
				La	
				So	
<b>LA</b>		FA		Fa	
				Mi	
				Re	
		MI		Do	
				Ti	
				La	
				So	
				Fa	
				Mi	
		RE		Do	
<b>SO</b>		DO		Do	
				Ti	
		TI			
				La	
				So	
		LA		Fa	
				Mi	
				Re	
		SO		Do	
				Ti	
				La	
				So	
<b>FA</b>		FA		Fa	
				Mi	
				Re	
		MI		Do	
				Ti	
				La	
				So	
				Fa	
				Mi	
		RE		Do	
<b>MI</b>		DO		Do	
				Ti	
		TI			
				La	
				So	
		LA		Fa	
				Mi	
				Re	
		SO		Do	
				Ti	
				La	
				So	
		FA		Fa	
				Mi	
				Re	
		MI		Do	
				Ti	
				La	
				So	
				Fa	
				Mi	
				Re	
		RE		Do	
<b>RE</b>		DO			
<b>DO</b>	0				

**FA**

## CHAPTER FOUR

# CAUGHT IN THE COSMIC LOOP

<b>DO</b>	DO	
<b>TI</b>	TI	
	LA	<b>T</b>
	SO	<b>O</b>
<b>LA</b>	FA	<b>P</b>
	MI	
	RE	
<b>SO</b>	DO	
	TI	<b>M</b>
	LA	<b>I</b>
	SO	<b>D</b>
<b>FA</b>	FA	<b>D</b>
	MI	<b>L</b>
	RE	<b>E</b>
<b>MI</b>	DO	
	TI	<b>B</b>
	LA	<b>O</b>
	SO	<b>T</b>
	FA	<b>T</b>
	MI	<b>O</b>
	RE	<b>M</b>
<b>RE</b>	DO	

In the previous chapter we identified that within every octave there exist four fundamental points: Do, So, Mi, and Re. These four fundamental points gave birth to three [inner] octaves: one between Do to So, one between So to Mi, and one between Mi to Re. For identification purposes the three inner octaves are labeled--top, middle, and bottom respectively. Also, we observed which vibrations from scale-0 reappeared as vibrations in scale-1. We learned that **SO** and **MI** from scale-0, two of the fundamental points, uniquely reappeared as *oscillating DO's* in scale-1; that is, *ascending and descending DO's*.

We shall now address this uniqueness by answering the following two questions for each of the vibrations in scale-1:

1. Which octave (top, middle, or bottom) is the vibration in?
2. What are its possibilities?

We shall begin by examining the vibrations *created between the four fundamental points*:

RE-27, MI-30, FA-32, SO-36, LA-40, and TI-45 are only in the bottom octave. They are diatonically created by DO-24 as it ascends to DO-48, or by DO-48 as it descends to DO-24 (see page 53).

RE-54, MI-60, FA-64, SO-72, LA-80, and TI-90 are only in the middle octave. They are diatonically created by DO-48 as it ascends to DO-96, or by DO-96 as it descends to DO-48.

RE-108, MI-120, FA-128, SO-144, LA-160, and TI-180 are only in the top octave. They are diatonically created by DO-96 as it ascends to DO-192, or by DO-192 as it descends to DO-96.

We find--when we examine *the four fundamental points*--DO-24 is in the bottom octave and creates the octave beyond itself as it doubles to DO-48. DO-192 is in the top octave and creates the octave before itself as it halves to DO-96. These two DO's both have existence in only one direction and in only one octave. On the other hand, *DO-48 and DO-96 have dual possibilities*. They are in, and create, the octave before themselves, and also, the octave beyond themselves. If you recall, in the last chapter we discussed that in order to *define* what "a thing"

Scale-0	Scale-1	
<b>DO</b> 192	DO 192	<p>was we needed to know what was before it and what was beyond it. By determining what was before it and what was beyond it--we fixed its place of existence. <b>Both DO-48 and DO-96, which have octaves before themselves and beyond themselves, meet this requirement.</b> Since these two DO's are the notes <b>MI</b> and <b>SO</b> from scale-0, we now have (in scale-0) two points of existence; and by finding these two points--a duality--in scale-0, we have once again completed a four, three, two, one symbology:</p> <p style="text-align: center;"><b>Four fundamental points,</b> create <b>three</b> octaves of radiations, create <b>two</b> points of existence, within <b>one</b> octave (scale-0).</p> <p>Note: Both <b>SO-96</b> and <b>MI-48</b> in scale-0 become (oscillating <u>Do's</u>) in scale-1, and reveal <b>a duality in the all to nothing octave of scale-0 that comes to life within scale-1</b>; a duality with separate points of existence, ascension and descension, and involution and evolution.</p> <p>This concept--that an octave has a duality--is obvious in the sense that we are surrounded by a dualistic world; for instance:</p>
	TI 180	
<b>TI</b> 168		
	LA 160	
	SO 144	
<b>LA</b> 128	FA 128	
	MI 120	
	RE 108	
<b>SO</b> 96	DO 96	
	TI 90	
	LA 80	
	SO 72	
<b>FA</b> 64	FA 64	
	MI 60	
	RE 54	
<b>MI</b> 48	DO 48	
	TI 45	
	LA 40	
	SO 36	
	FA 32	
	MI 30	
	RE 27	
<b>RE</b> 24	DO 24	
<b>DO</b> 0		

Man, taken as an octave, should have a dualistic nature--religion bears this out as Man having both Body and Spirit. The nucleus of an atom, if taken as an octave, should also have a dualistic nature--scientific investigation reveals that the proton and neutron satisfy the nucleus' duality. Even electricity and magnetism are found as a duality in the electromagnetic spectrum. The duality is also the reason why two identical atoms combine to form a diatomic molecule. *This is the state of the Universe!* All of these--along with many others--are indications of the duality that exists within the inner structure of the octave. In some manifestations, the *duality* is obscured; while in others, it is obvious. In either case, *the perception of its existence* will, indubitably, increase Man's clarity of understanding.

## MATHEMATICS OF THE DUALITY

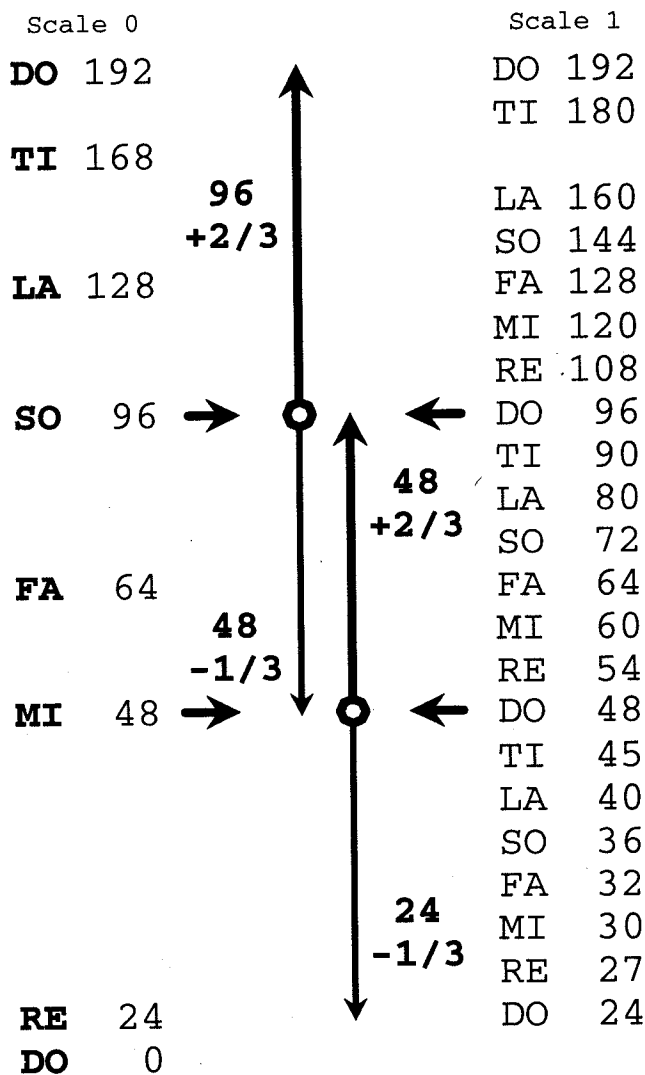

**SO** has a possibility of 96 in its ascension and 48 in its descension, or a total *range of existence* of 144 (96 + 48). 2/3 is an ascending octave (plus) and 1/3 is a descending octave (minus).

**MI** has an ascension of 48 and a descension of 24, or a total *range of existence* of 72 (48 + 24). Within this *range of existence*, 2/3 is ascension (plus) and 1/3 is descension (minus).

We have designated the octave's line of ascension with an "up arrow" and its line of descension with a "down arrow". **Up arrows represent +2/3 of the "something" and down arrows represent -1/3 of the "something"**.

In addition, **SO** and **MI** have a unique mutual relationship. **SO** and **MI** coexist in the octave where "their *ranges of existence* overlap" (page 54), that is, **SO's** -1/3 down arrow and **MI's** +2/3 up arrow *both exist in the same place*; thus, **YOU CANNOT ISOLATE SO WITHOUT GETTING A PART OF MI--AND VICE VERSA.**

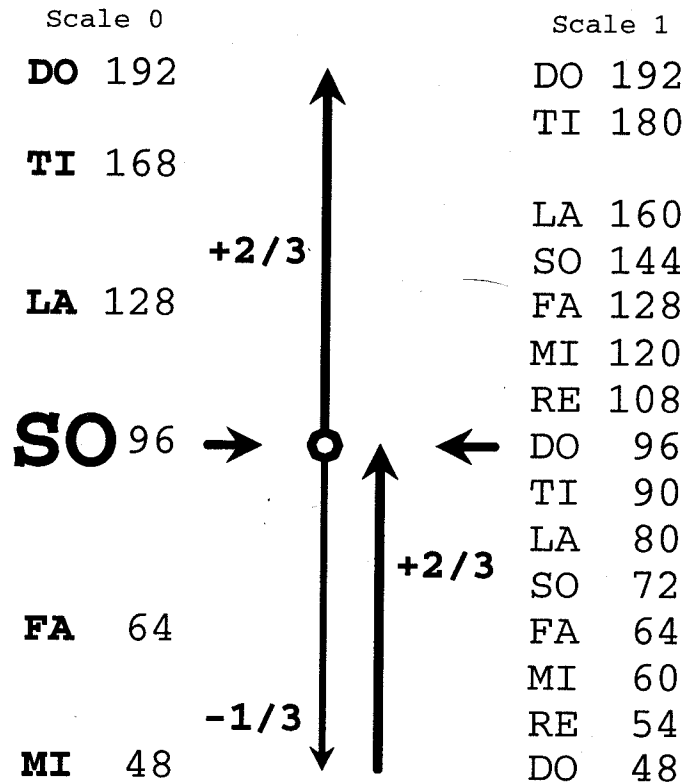

If we broke the octave apart and observed only **SO's** existence, 48 to 192, we would find it *contains three arrows*, one -1/3 down arrow and two +2/3 up arrows. Note: As discussed, one +2/3 up arrow is from **MI's range of existence**.

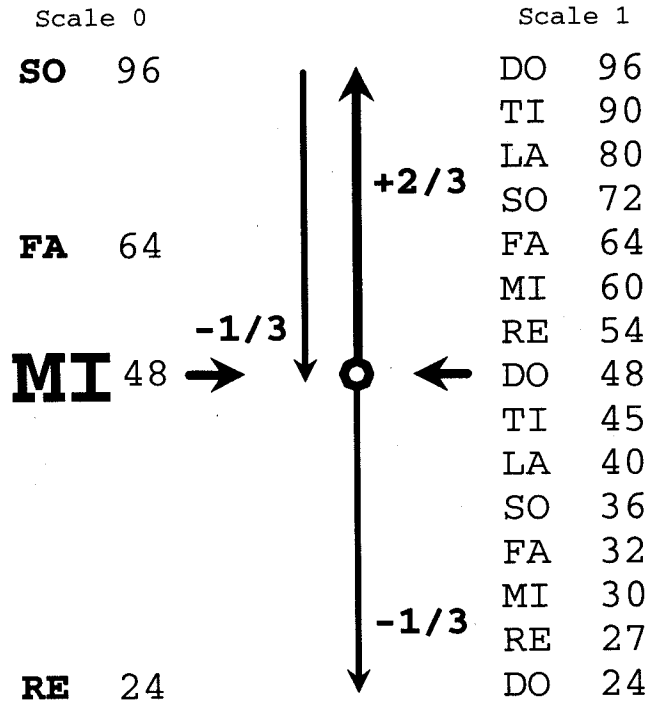

If we broke the octave apart and observed only **MI**'s existence, 24 to 96, we would also find *three arrows*, one  $+\frac{2}{3}$  up arrow and two  $-\frac{1}{3}$  down arrows.

## THE ATOM

Let us compare this structure to the nucleus of an atom. The nucleus of an atom consists of protons and neutrons. Scientists have postulated that the protons and neutrons each have their own three inner constituents called quarks. Protons contain two up quarks and one down quark. Neutrons contain two down quarks and one up quark. Up quarks have a  $+\frac{2}{3}$  charge, down quarks have a  $-\frac{1}{3}$  charge. Is it only a coincidence that if we place the proton at **SO** and the neutron at **MI**, we find the proton's quarks correspond exactly to the structure of the up and down arrows in **SO**'s range of existence, and the neutron's quarks correspond exactly to the structure of the up and down arrows in **MI**'s range of existence?

If, in the three octaves of scale-1, we can find *two things*--the proton and neutron--we would therefore find, in the nine octaves of scale-2, *six things*. Is it, again, only a *coincidence* that scientists have discovered *six* subatomic particles related to the proton and neutron?

With the knowledge of the structure of inner octaves, it is possible to explore the configuration of the up and down quarks within these six subatomic particles and the existence of "strange", "charm", "bottom", and "top" quarks.

For now, let us return to the main theme of this chapter--finding ourselves in an oscillating Universe. Previously, we separated the three forces; then, stretched and rumbled the fabric of the universe to bring the forces and structure into alignment. Next, we studied the inner, diatonic structure of the octave, i.e., the octave of the affirming force (Do). Now, if we observe the inner, diatonic structure of the affirming force in conjunction with the presence of the denying and the reconciling principles, **we shall be able to comprehend why matter is bound together in webs of harmonic stability.** We commence with this assertion: Do will identify the affirming force, or force plus; La will identify the reconciling force, or force neutral; and Fa will identify the denying force, or force minus. What we will now discuss focuses primarily on the “dynamic relationship” between Do and Fa. If the forces--Do and Fa--are equal, then La becomes truly neutral; that is, the juxtaposition where Do (the positive principle) blends with Fa (the negative principle) to actualize La (the neutralizing principle). Therefore, we shall exclude La for the moment.

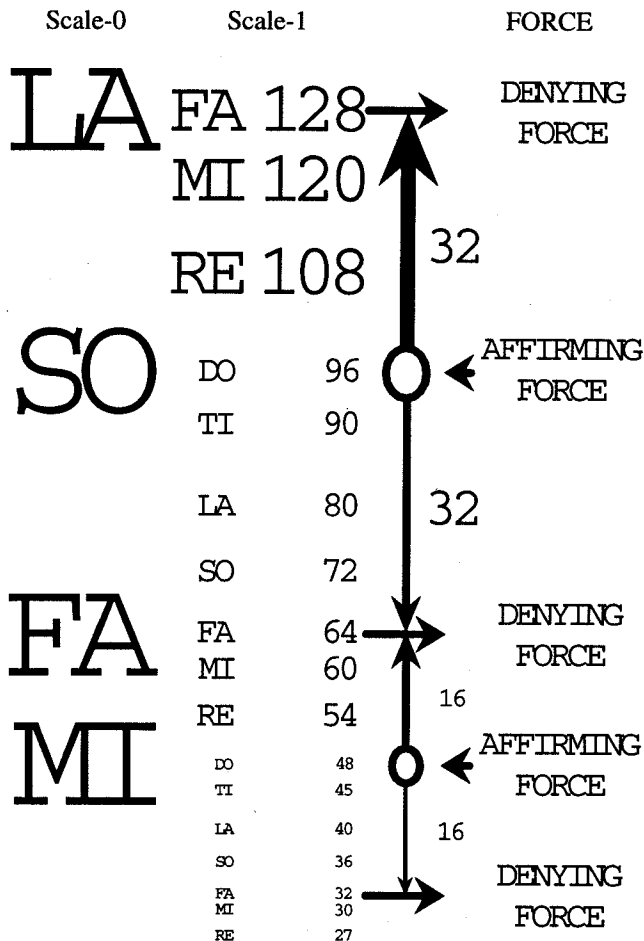

**We shall begin with the duality.** MI and SO in scale-0 (by becoming DO's in scale-1) become *affirming forces* within scale-1. Next, if we examine the movement of either one of these affirming forces...we begin to comprehend the **inevitability of oscillations.** This becomes very clear when we realize that the presence of a **denying principle** at Fa will *arrest the ascending and descending movement* of an affirming Do. This “denying of the ascending and descending movement”, *if it is symmetrical, becomes a point of oscillation.* The **duality** of SO and MI is created by this *symmetry*, two “points of oscillation” in scale-1.

*Oscillations* occur because **all points of existence--** that is, all oscillating Do's--are mathematically centered between the two ends of a "symmetrically-distanced denying force". For example: DO-768, an affirming force in scale-1, is denied at FA-1024 in its octave of ascension (*1024 is exactly 256 vibrations away from 768*); in addition, DO-768 is, likewise, denied at FA-512 in its octave of descension (*512 is also exactly 256 vibrations away from 768*). If DO tries to ascend, it is denied at FA-1024; if DO then tries to descend, it is again denied, but this time at FA-512. The affirming force at DO-768 will *o-s-c-i-l-l-a-t-e* between the two ends of this "symmetrically-distanced denying force".

All Mi's and So's (the vibrations that become oscillating Do's in the next inner scale) *exist at points of harmonic stability*. Their "ranges of existence" overlap (page 54); their "oscillations" do not (page 57). They are *separate* from each other, but *forever bound* within the inner structure of the Law of Seven!

In addition, the 71 vibrations (in the three scales of an octave) are **halved** by the FA in scale-0, that is, *35 of the 71 vibrations are above the FA, and 35 of the 71 vibrations are below the FA*. The result is, all Do's perceive a full range of 71 vibrations....They do not manifest an **octave of 71 vibrations** (Do to Do), but rather, **oscillate 71 vibrations** (Fa to Fa); i.e., *35 up and 35 down*, between the two ends of a "symmetrically-distanced denying force" (see page 60).

As we study the two oscillations in an octave, we find the oscillation at **SO** is more conspicuous than the oscillation at **MI**. Principally because the oscillation at **SO** *can be found oscillating in scale-0*, that is, when **SO** becomes a **DO** in scale-1 it begins to oscillate between two scale-1 FA's, and these two scale-1 FA's correspond with a **LA** and **FA** in scale-0; whereas, when **MI** becomes an oscillation in scale-1, it *cannot be found oscillating in scale-0*. As a result, we will call the oscillation at So the "**major oscillation**" and the oscillation at Mi the "**minor oscillation**".

0	1	2	SCALE
DO	DO	Do	1536 35
		Ti	1488 34
	TI		1440 33
		La	1408 32
TI		So	1344 31
	LA	Fa	1280 30
		Mi	1248 29
		Re	1200 28
	SO	Do	1152 27
		Ti	1128 26
		La	1088 25
		So	1056 24
LA	FA	Fa	1024 23
		Mi	1008 22
		Re	984 21
	MI	Do	960 20
		Ti	948 19
		La	928 18
		So	912 17
		Fa	896 16
		Mi	888 15
		Re	876 14
	RE	Do	864 13
SO	DO	Do	768 12
		Ti	744 11
	TI		720 10
		La	704 9
		So	672 8
	LA	Fa	640 7
		Mi	624 6
		Re	600 5
	SO	Do	576 4
		Ti	564 3
		La	544 2
		So	528 1
FA	FA	Fa	512 0
		Mi	504 1
		Re	492 2
	MI	Do	480 3
		Ti	474 4
		La	464 5
		So	456 6
		Fa	448 7
		Mi	444 8
		Re	438 9
	RE	Do	432 10
MI	DO	Do	384 11
		Ti	372 12
	TI		360 13
		La	352 14
		So	336 15
	LA	Fa	320 16
		Mi	312 17
		Re	300 18
	SO	Do	288 19
		Ti	282 20
		La	272 21
		So	264 22
	FA	Fa	256 23
		Mi	252 24
		Re	246 25
	MI	Do	240 26
		Ti	237 27
		La	232 28
		So	228 29
		Fa	224 30
		Mi	222 31
		Re	219 32
	RE	Do	216 33
RE	DO		192 34
DO			0 35

Note: The major oscillation mathematically indicates the presence of a *denying principle*--another inner octave coexisting within the three octaves of radiations. FA at 1/3 (64 vibrations) doubles to LA at 2/3 (128 vibrations), or LA at 2/3 (128 vibrations) halves to FA at 1/3 (64 vibrations). This doubling or halving is not concurrent with the progression of inner octaves caused by the four fundamental points--1, 1/2, 1/4, and 1/8; but, it does identify that LA and FA exist at the two ends of the octave of the “symmetrically-distanced denying force”!

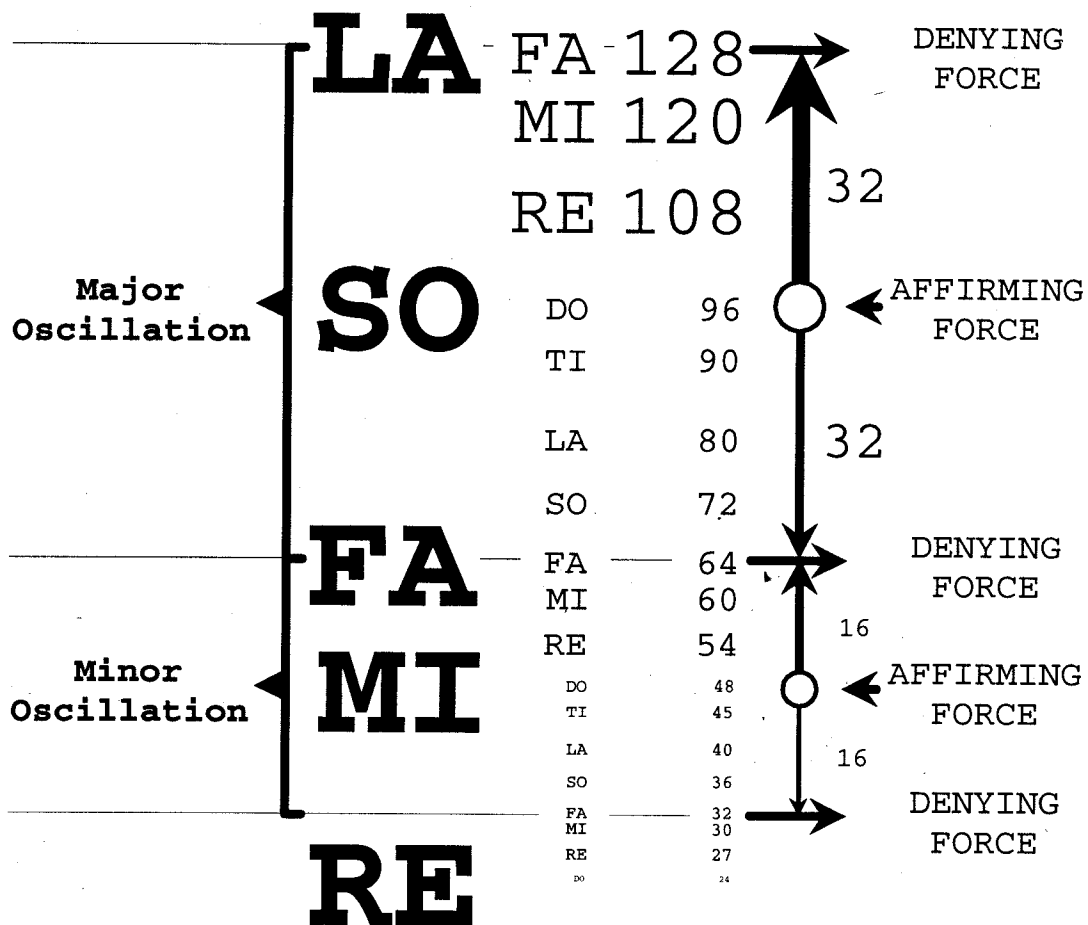

The major and minor oscillations--the duality--are rudimentary, and can even be found in science behind the formation of matter itself. In the nucleus of an atom, it is the major oscillation [the number of protons] that determines the element; i.e., an atom of hydrogen always has one proton--it can have no neutrons, one neutron, or two neutrons, but it will still be hydrogen because it is the “total number of protons” [not the total number of neutrons] that determines the element. Note: The only difference in these three hydrogen atoms is their weight.

**0 1 2 3 SCALE**

LA	Fa	fa	2048	35	2048
	mi		2040	34	
	re		2028	33	
MI	do		2016	32	
	ti		2010	31	
	la		2000	30	
	so		1992	29	
	fa		1984	28	
	mi		1980	27	
	re		1974	26	
Re	do		1968	25	
MI	Do		1920	24	
	ti		1908	23	
Ti			1896	22	
	la		1888	21	
	so		1872	20	
La	fa		1856	19	
	mi		1848	18	
	re		1836	17	
S	o		1824	16	
	ti		1818	15	
	la		1808	14	
	so		1800	13	
F	a		1792	12	
	mi		1788	11	
	re		1782	10	
M	i		1776	9	
	ti		1773	8	
	la		1768	7	
	so		1764	6	
	fa		1760	5	
	mi		1758	4	
	re		1755	3	
Re	do		1752	2	
RE	Do		1728	1	
S	O	Do	1536	0	1536
	ti		1512	1	
Ti			1488	2	
	la		1472	3	
TI		so	1440	4	
	La	fa	1408	5	
		mi	1392	6	
		re	1368	7	
S	o		1344	8	
	ti		1332	9	
	la		1312	10	
	so		1296	11	
LA	F	a	1280	12	
		mi	1272	13	
		re	1260	14	
M	i	do	1248	15	
		ti	1242	16	
		la	1232	17	
		so	1224	18	
		fa	1216	19	
		mi	1212	20	
		re	1206	21	
Re	do		1200	22	
S	O	Do	1152	23	
		ti	1140	24	
	Ti		1128	25	
		la	1120	26	
		so	1104	27	
La	f	a	1088	28	
		mi	1080	29	
		re	1068	30	
S	o		1056	31	
		ti	1050	32	
		la	1040	33	
		so	1032	34	
FA	F	A	1024	35	1024

Even the filling of an atom's orbitals is influenced by the major oscillation. A shell that has five orbitals of equal energy will get ten electrons--*two electrons for each orbital*--but before any one of these five orbitals is allowed to have a second electron, all five of these orbitals must have their first electron. In other words, all orbitals receive one electron to complete their major oscillation before *any* orbital fills its minor oscillation.

Previously, we calculated and then examined the **three scales of an octave--scale-0, scale-1, and scale-2**; now we must calculate and examine the corresponding *three scales of an oscillation*. Since the oscillation first occurs in scale-1, we will begin with that scale. Therefore, **the three scales of an oscillation** become *scale-1, scale-2, and scale-3*.

The major oscillation in the "all to nothing" octave of 3072 is the oscillation of 1024. It originates at 1536 (SO in scale-0) and becomes an "oscillating DO" in scale-1. As this oscillating DO-1536 strives to complete its octaves of ascension and descension--it is *denied*; e.g., DO-1536 is denied in its octave of ascension at FA-2048 (512 vibrations away); and it is denied at FA-1024 in its octave of descension (*also 512 vibrations away*). The resulting oscillation, is the oscillation of 1024 (512 plus 512). As in the three scales of an octave (page 58), there are--in the three scales of an oscillation--71 vibrations. Note: 35 are above 1536 and 35 are below 1536.

Our examination into the structure of oscillations will allow us to comprehend the formation of Life itself. One of Life's first molecules to form is the RNA molecule. The term RNA stands for ribonucleic acid. Scientists have discovered three unique types of RNA: *messenger RNA (mRNA), transfer RNA (tRNA), and ribosomal RNA (rRNA)*.

Here, we shall not try to conduct a biology lesson, but will, however, touch the basics "just enough" to

reveal how one of these RNA molecules, transfer RNA, conforms to the oscillating structure within the Law of Seven.

Messenger RNA strands configure along sections of the DNA molecule. These strands carry the code contained in the DNA [of how to arrange amino acids into proteins] to the site of the ribosome. At the ribosome, the messenger RNA's code is read. Here, the transfer RNA molecules arrive, each carrying one of the 20 different amino acids used in protein synthesis. Next, by matching the codons of the messenger RNA strand, the transfer RNA molecules read the codes and deposit their individual amino acids into the proper place in the sequence.

At this time, let us focus on the unique structure of transfer RNA:

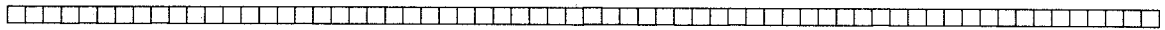

Transfer RNA is a small chain believed to be between 75 to 85 nucleotides long. The chain is folded back on itself so that its two ends are adjacent to each other. For the most part, the nucleotides that are across from each other are linked. However, there are two notable exceptions.

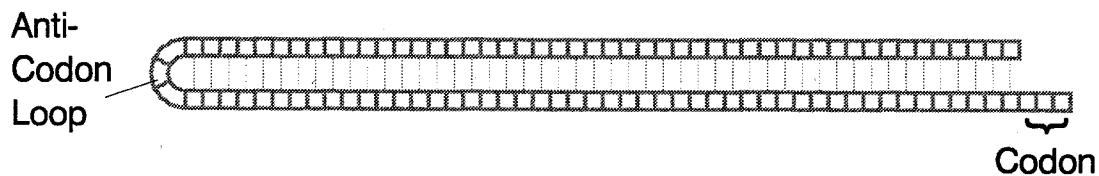

*Three nucleotides on one of the adjacent ends remain unlinked.* These three unlinked nucleotides are called a “codon”. This is known as the “acceptor end” of the transfer RNA molecule.

*There are also three unlinked nucleotides at the fold.* This codon is called the “anti-codon loop”. The transfer RNA's anti-codon loop (three nucleotides) is designed specifically to join with one of the messenger RNA's codons (also three nucleotides). This “joining” of the anti-codon loop to a particular messenger RNA codon, ensures that the amino acid attached to the acceptor end of the transfer RNA molecule is the correct amino acid coded for by the messenger RNA strand.

After depositing its amino acid at the proper place in the sequence, the transfer RNA molecule disconnects from the messenger RNA strand. The acceptor end of the transfer RNA molecule can now pick up another like amino acid and return to the ribosome, where this process--its anti-codon loop matching a codon of a messenger RNA strand--repeats itself.

Further scientific investigation into the structure of transfer RNA has revealed an additional bend. The transfer RNA molecule is shaped in the form of a rough "L"...with the two adjacent ends on the shorter side of the "L".

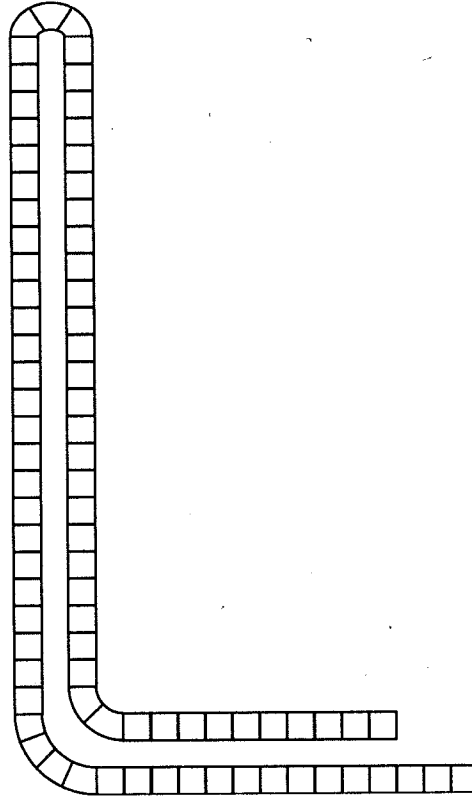

## THE OSCILLATION

As we examine the three scales of an **oscillation** (see page 63), something quite remarkable comes into view:

1. If we count the beginning and ending FA's together as one, we find there are 70 vibrations and 79 notes in the three scales of an oscillation (*tRNA is a chain believed to be between 75 to 85 nucleotides long*).

2. Next, if we fold the oscillation back on itself at the triple Do's (*tRNA's anti-codon loop*) and align the oscillation's ascending and descending vibrations, we find there is a recurring structure in the pairing of certain notes (*in tRNA the adjoining nucleotides are linked*).

3. After folding and linking the oscillation, we discover that there are exactly three, unpaired vibrations protruding at one end (*in tRNA three nucleotides on one of the adjacent ends remain unlinked*).





We repeat. *The octave's ascending vibrations fold back and pair with its descending vibrations. It links--and totals--these vibrations; then, to verify the accuracy of its oscillation, it folds again at the "double Do's" [as a check] to see if the totals of the linked pairs match. If they do...the oscillation is correct.*

Next, the extra vibrations calculated beyond the ends of the oscillation disconnect. The side losing the extra vibrations becomes shorter, causing the structure to resemble an "L" (page 62). In addition, there are exactly three unpaired vibrations on one end. **Precisely the structure of transfer RNA!**

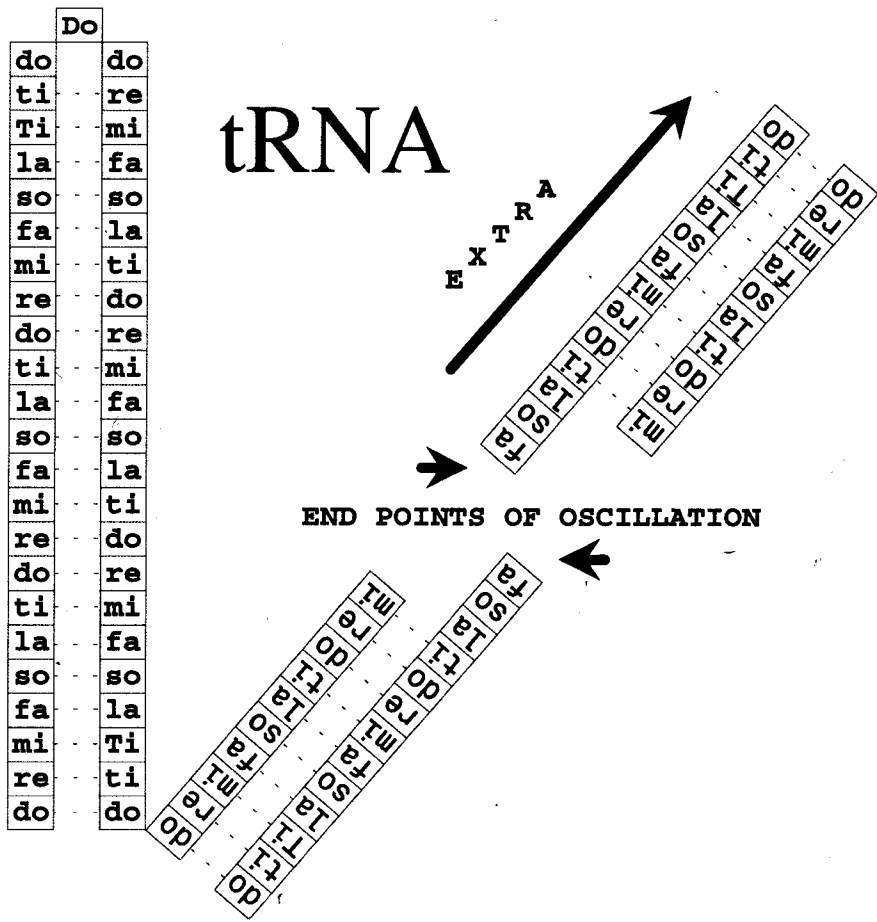

We can almost envision, in this process of checking itself--during the second fold--as the pair of vibrations below the "double Do's" fold alongside the pair of vibrations above the "double Do's", the nucleotides on one side (the outside of the fold) are s-t-r-e-t-c-h-e-d. Stretched so much, the structure does not fully recover after this check, as it tries to unfold. Because of the stretched area, it remains partially bent and ends up looking like an "L" (it starts out straight, folds and links; it then configures as a "U" while it checks itself; finally, as it tries to recover, it takes the shape of an "L").

	Do	
do		do
ti		re
Ti		mi
la		fa
so		so
fa		la
mi		ti
re		do
do		re
ti		mi
la		fa
so		so
fa		la
mi		ti
re		do
do		re
ti		mi
la		fa
so		so
fa		la
mi		Ti
re		ti
		do

Perhaps the process of Life began as the amino acids were expressed in octave form. This resulted in two consecutive octaves forming at each amino acid. These two octaves then folded over onto each other to pair their vibrations. They folded again to verify the accuracy of their composition, and then broke free to form the first transfer RNA molecules. These primordial transfer RNA molecules, by completing the duality of their anti-codon loops, constructed individual messenger RNA codons. When these primordial transfer RNA molecules sequentially attached to the amino acids of the first protein chain, their primordial messenger RNA codons (at their anti-codon loops) also sequentially joined to become the first strand of messenger RNA. This primordial messenger RNA strand--by completing the duality of its nucleotide sequence--subsequently constructed an adjacent strand that served as a *memory* strand; that is, any nucleotide sequence that matched duality with this memory strand would be an exact copy of the primordial messenger RNA strand. This original memory strand, by completing its duality, constructed a complementary memory strand and then combined with it to become the first DNA molecule, which is of course, the Master Blueprint of Life.

However, let us not speculate; but rather, let us continue to investigate the structure within both the octave and the oscillation. For only a clear understanding of all they imply can make it possible for us--as individuals--*to free ourselves, from ourselves...to where we are no longer, merely, caught in the cosmic loop!*

With further investigation into the oscillations that exist within inner octaves, we find oscillations appearing not only in other parts of the octave, but appearing within other oscillations as well.

do do re mi fa so la ti do re mi

do ti Ti la so fa mi re do ti la so fa

Scale 0	Scale 1	Scale 2	
DO 1536	DO 1536	Do 1536	
	TI 1440	Ti 1488	
TI 1344		La 1408	
	LA 1280	So 1344	
		Fa 1280	2
		Mi 1248	5
	SO 1152	Re 1200	6
		Do 1152	
LA 1024	FA 1024	Ti 1128	
		La 1088	
		Fa 1024	1
		Mi 1008	2
	MI 960	Re 984	8
		Do 960	
		Ti 948	1
		La 928	2
		So 912	8
		Fa 896	
		Mi 888	
		Re 876	
SO 5	RE 864	Do 864	
1	DO 768	Do 768	
2	TI 720	Ti 744	
		La 704	
	LA 640	So 672	
		Fa 640	1
		Mi 624	2
		Re 600	8
	SO 576	Do 576	
		Ti 564	
		La 544	
		So 528	
FA 512	FA 512	Fa 512	
		Mi 504	
		Re 492	
	MI 480	Do 480	6
		Ti 474	4
		La 464	
		So 456	
		Fa 448	
		Mi 444	
		Re 438	
	RE 432	Do 432	
MI 2	DO 384	Do 384	
5	TI 360	Ti 372	
6		La 352	
		So 336	
	LA 320	Fa 320	
		Mi 312	
		Re 300	6
	SO 288	Do 288	4
		Ti 282	
		La 272	
		So 264	
	FA 256	Fa 256	
		Mi 252	
		Re 246	
	MI 240	Do 240	3
		Ti 237	2
		La 232	
		So 228	
		Fa 224	
		Mi 222	
		Re 219	
RE 192	RE 216	Do 216	
	DO 192		

Previously we defined the major and minor oscillations that emerged within scale-1. They created a duality in scale-0, and engulfed half of the scale-0 octave in oscillations. Now we will observe the oscillations that occur in scale-2, and their relationship to the major and minor oscillations in scale-1.

In scale-2, six oscillations emerge. Two oscillations have a length of 128 vibrations and appear in the major oscillation (512 vibrations). Two oscillations have a length of 64 vibrations and appear within the minor oscillation (256 vibrations). Note: *The oscillations in the major and minor oscillations--reduce the oscillating portion of scale-1 by one-half.*

The two remaining oscillations--32 and 256 vibrations--appear outside of, but adjoin with, the outer ends of the major and minor oscillations. Note: *The oscillations outside of the major and minor oscillations--reduce the nonoscillating portion of scale-1 by one-half.*

**Axiom: Whether we are in an octave, or within inner octaves, half is in oscillation!**

We formerly unearthed that *below* the major oscillation of 512 vibrations there was an oscillation of 256 vibrations, i.e., the minor oscillation. Now we discover that *above* the major oscillation there is also an oscillation of 256 vibrations. It is very interesting that all major oscillations have this configuration--a *succeeding oscillation* the exact, same size as their minor oscillation. Perhaps, with a little investigation we can uncover the significance of this phenomenon. We shall begin by analyzing the oscillating structures produced within the major and minor oscillations.

## DNA

These oscillating structures can be found in the DNA molecule (see page 69). DNA, the Octave of Life, consists of only two building blocks--**purine** and **pyrimidine** [*there are two oscillations within an octave, i.e., the major oscillation and the minor oscillation*]. In addition, there are only two kinds of **purine**--*adenine* and *guanine*; and only two kinds of **pyrimidine**--*thymine* and *cytosine* [*within both the major and the minor oscillation, there comes into existence, in scale-2, two oscillations*]. If we identify these four scale-2 oscillations by their prominent ends of denial, that is, by the end containing the most denying forces--Fa's--we find two of the four oscillations have *three notes* of denial FA, FA, and Fa; while the other two oscillations have only *two notes* of denial FA and Fa. In DNA, *guanine* bonds with *cytosine* by forming three hydrogen bonds, whereas, *adenine* bonds with *thymine* by forming two hydrogen bonds. The inner structure of oscillations is in exact correspondence with the bonding arrangements of purine and pyrimidine, or rather, we should say, **the bonding arrangements of *guanine, adenine, cytosine, and thymine* [the respective parts of purine and pyrimidine] correspond exactly to the inner structure of an octave's oscillations.**

During DNA replication, the fixed distance between the double helix, sugar phosphate rails only allows for a "long" purine base to bond with a "short" pyrimidine base; that is, two purine molecules would be too long for the space and two pyrimidine molecules would be too short. The oscillations in scale-2 allow for an exact bonding between a "128" oscillation and a "64" oscillation. The top of *cytosine's* oscillation bonds with the bottom of *guanine's* oscillation--64 to 128; and the top of *adenine's* oscillation (like a dog biting its tail) bonds with the bottom of *thymine's* oscillation--128 to 64.

### **THE OSCILLATIONS, WITHIN THE LAW OF OCTAVES, REVEAL THE STRUCTURE BEHIND THE ARRANGEMENT OF LIFE ITSELF!**

Now, back to the phenomenon; remember, beyond the oscillation of 512 there was another oscillation with a length of 256 vibrations (page 67). This subsequent oscillation (256 vibrations) represents another pyrimidine molecule; and this additional pyrimidine molecule will contain another pyrimidine base--*uracil*. Note: *Uracil*, an oscillation with a length of 64 vibrations, is configured exactly like *thymine*. By substituting *uracil-64* for *thymine-64*, DNA can be transformed into the language of RNA.

# DNA

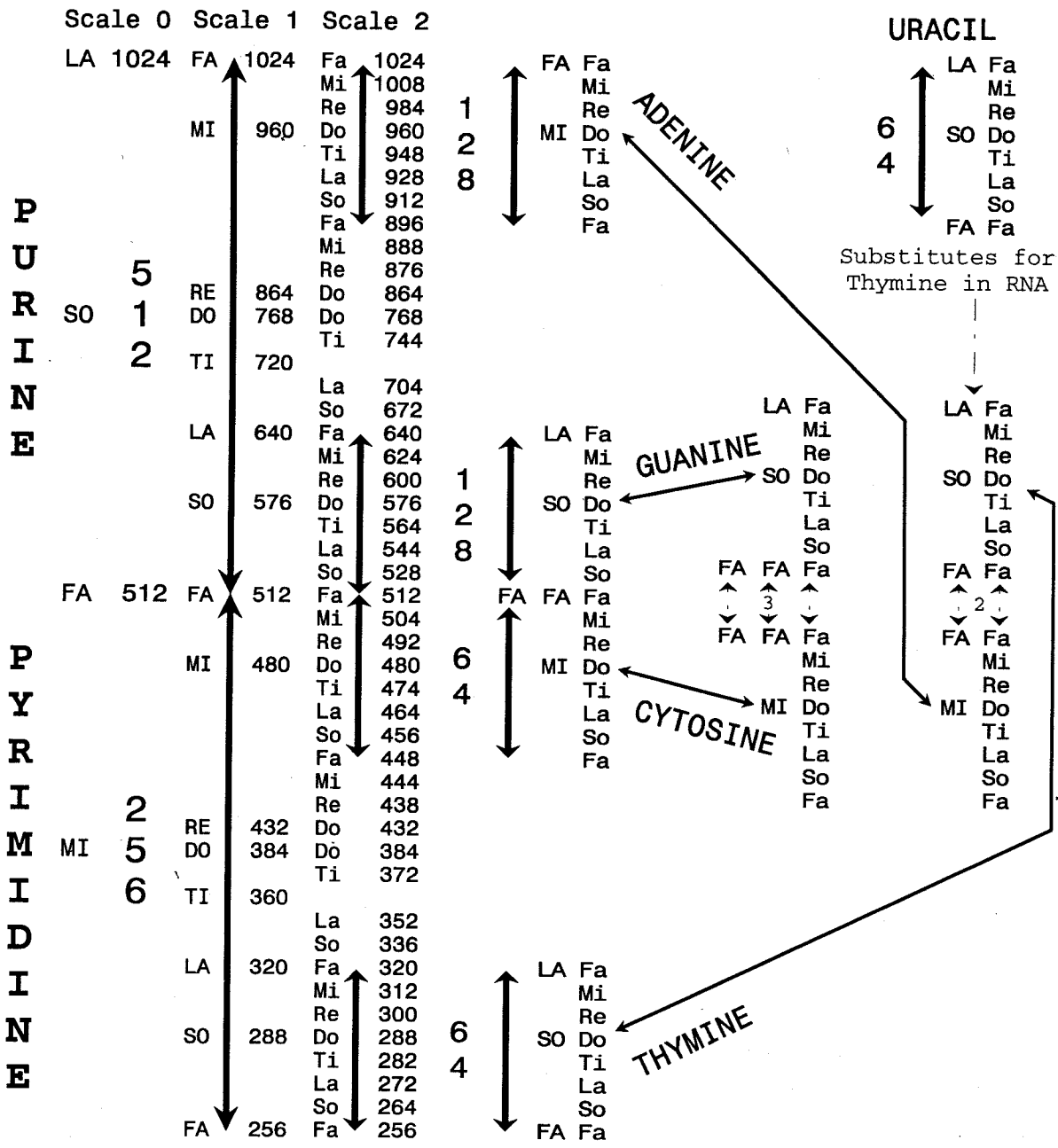



# INEXACTITUDES

Reflections of a seeker in pursuit of the fifth striving.

INEXACTITUDES, INEXACTITUDES, WHERE ART ALL THOU  
INEXACTITUDES?

*For I am constantly astounded  
That my moving center is impounded  
By years of evolutionary mutation--I am hounded.*

*How can I dissolve what evolved  
Without any say, nor with any great plan  
And even by accident, to be a Man.*

*Even the DNA has a fix  
According to the environmental mix  
From cells, to tissues, to organs--to 3-brained "this".*

*The chemicals steadfast  
Clinging to the past of all they know  
And "I" in the middle trying to grow.*

*How to sway the habitual clones  
I need to know, for I cannot be cast to the bones  
I have come too far, seen the other zones.*

*Blessed miracle percentage developed  
Destroy what lives below the first floor  
Extinguish those nonexistent hoards, I implore.*

*P. K. Ritchie--THE DOG--1991*

**so**

## CHAPTER FIVE

# THE WAY UP WAS THE WAY DOWN

We shall now begin to define the fabric of the Universe. A fabric that unfolds beyond the conceptual “*single octave’s inner structure*” we have been exploring. Gurdjieff alludes to this idea in *All and Everything*.

“It is necessary to notice that in the Great Universe all phenomena in general without exception wherever they arise and manifest, are simply successively law-conformable ‘Fractions’ of some whole phenomenon which has its prime arising on the ‘Most Holy Sun Absolute.’

“And in consequence, all cosmic phenomena, wherever they proceed, have a sense of ‘objectivity.’

“And these successively law-conformable ‘Fractions’ are actualized in every respect, and even in the sense of their involution and evolution, owing to the chief cosmic law, the sacred ‘Heptaparashinokh.’”<sup>14</sup>

We can find clues in the wording of the first paragraph: “all phenomena”, “without exception”, and “law-conformable ‘Fractions’”; and also in the third paragraph, where we learn that these “...‘Fractions’ are actualized in every respect, and even in the sense of their involution and evolution, owing to the chief cosmic law, the sacred ‘Heptaparashinokh’”; that is, they are diatonic. With this idea we can surmise that *if all phenomena are diatonic, then all forces are diatonic!* Structurally, this infers that the fabric of the Universe does not unfold from a single octave--a single force; but from three octaves--a trinity of three forces. In the last chapter *we recognized that the three forces coexist within the octave--the affirming force exists at DO, the denying force exists at FA, and the reconciling force exists at LA. Now, we must structure these forces as diatonic octaves.* We shall use the octave of 144 vibrations (288 vibrations to 144 vibrations). The octave of 144 allows us to compute *all three diatonic octaves* at whole numbers, which makes spotting the dog a heck of a lot easier to do!

The affirming force (the octave of 144 vibrations) creates seven diatonic vibrations as it descends from 288 vibrations to 144 vibrations. *The reconciling force that exists at the LA of the affirming force's octave is the DO of its own octave.* It, too, creates its own seven diatonic vibrations that come into being as it descends from 240 vibrations to 120 vibrations. Finally, *the denying force, which exists at the FA of the affirming force's octave, is also the DO of its own octave,* and likewise, creates its own seven diatonic vibrations that come into being as it descends from 192 vibrations to 96 vibrations.

AFFIRMING FORCE		RECONCILING FORCE		DENYING FORCE
DO 288				
TI 270				
LA 240	→	DO 240		
		TI 225		
SO 216				
		LA 200		
FA 192	→	→ → →	→	DO 192
MI 180		SO 180		TI 180
RE 162				
		FA 160		LA 160
		MI 150		
DO 144				SO 144
		RE 135		
				FA 128
		DO 120		MI 120
				RE 108
				DO 96

Perhaps the first thing you will notice about this diagram is that although the three forces were calculated individually and separately to create a diatonic octave, that is, their own personal set of seven diatonic vibrations, we find some of these vibrations are also vibrations in either one or both of the other octaves.

**THIS SHARING OF DIATONIC VIBRATIONS--MUTUAL POINTS OF CONTACT--  
ALLOWS THE OCTAVES TO INFLUENCE EACH OTHER AT THESE POINTS,  
AND AT THE SAME TIME, BINDS THE FORCES TOGETHER.**

Later we shall see--due to this sharing of vibrations--how each vibration in an octave becomes a DO, TI, LA, SO, FA, MI, and RE [in a specific sequence], in what we call "outer octaves".

*The significance of the diagram becomes evident when we realize that it identifies the natural, downward flow of forces, as well as the place where each force begins.* Now, we must look at the diagram regarding the ascension of forces, or in other words, *how to get from the bottom back to the top.* By relabeling the diagram the dog is revealed!

2ND SHOCK OCTAVE		1ST SHOCK OCTAVE		AFFIRMING OCTAVE
DO 288				
TI 270				
LA 240	→	DO 240		
		TI 225		
SO 216				
		LA 200		
FA 192	→	→ →	→	DO 192
MI 180		SO 180		TI 180
RE 162				
		FA 160		LA 160
		MI 150		
DO 144	←	← ←	←	SO 144
		RE 135		
				FA 128
		DO 120	←	MI 120
				RE 108
				DO 96

We now have the precise configuration of three octaves that can, by their proper sequencing, achieve ascension. In the above diagram, descension proceeds downward from left to right while ascension proceeds upward from right to left. Notice that from the point of view of our new affirming octave (DO-96 to DO-192) two forces (or octaves) must begin at its vibrations MI-120 and SO-144. Note: The octaves that must be *purposely initiated* at MI-120 and SO-144 create the *shocks* necessary for DO-96 to ascend to DO-192.

Gurdjieff's cosmology employs this principle repeatedly without telling us, directly, how and why such a configuration for the passage of forces up an octave became necessary. The simple answer is revealed when we realize that the natural, downward flow of the three initializing forces creates a configuration, which is, precisely, the same configuration that an octave must create in order to achieve ascension, or in other words, the way up was the way down!

## RIBOSOMAL RNA

*If we configure the forces (the affirming, the denying, and the reconciling) as three scale-1 octaves, a remarkable representation of yet another one of the building blocks of Life is revealed...ribosomal ribonucleic acid or "rRNA". Ribosomal RNA is a long, chain macromolecule about 1/10 as large as a wavelength of visible light, or 1/40,000 millimeter. It consists of two subulates: a large subulate and a small subulate. The large subulate has two RNA molecules in association with 34 proteins; the small subulate is one RNA molecule and 21 proteins.*

Chapter four revealed the duality that exists within the inner structure of the octave, explaining why the proton and neutron form a duality called the nucleus, or even why the nucleus and electron cloud form a duality called the atom. In ribosomal RNA we also find this exact, structural result (see page 77). **The affirming force (positive) and reconciling force (neutral) unite to form the large subulate, and the denying force (negative) forms the small subulate;** these two subulates form the ribosomal RNA molecule. Note: When *the three scale-1 octaves* of the affirming force are united with *the three scale-1 octaves* of the reconciling force, a structure with exactly 34 vibrations is revealed. *The three scale-1 octaves* of the denying force produce a structure with 21 vibrations. This gives us **two united forces with 34 vibrations, and one force with 21 vibrations!**

Is it, again, only a coincidence that ribosomal RNA has **two molecules with 34 proteins** in its large subulate and **one molecule with 21 proteins** in its small subulate, or is it we have--once again--found the dog?

**THE MORE WE STUDY THE LAWS OF WORLD-CREATION AND WORLD-MAINTENANCE, THE MORE WE FIND IN PERFECT ACCORDANCE WITH THEM!**

**POSITIVE**

1	DO 1296.00	
2	TI 1215.00	<b>NEUTRAL</b>
3	LA 1080.00	1080.00 DO
4		1012.50 TI
5	SO 972.00	
6		900.00 LA
7	FA 864.00	
8	MI 810.00	810.00 SO
9	RE 729.00	
10		720.00 FA
11		675.00 MI
12	DO 648.00	
13	TI 607.50	607.50 RE
14	LA 540.00	540.00 DO
15		506.25 TI
16	SO 486.00	
17		450.00 LA
18	FA 432.00	
19	MI 405.00	405.00 SO
20	RE 364.50	
21		360.00 FA
22		337.50 MI
23	DO 324.00	
24	TI 303.75	303.75 RE
25	LA 270.00	270.00 DO
26		253.13 TI
27	SO 243.00	
28		225.00 LA
29	FA 216.00	
30	MI 202.50	202.50 SO
31	RE 182.50	
32		180.00 FA
33		168.75 MI
34		151.88 RE

# rRNA

**L  
A  
R  
G  
E  
  
S  
U  
B  
U  
L  
A  
T  
E**

**NEGATIVE**

1	DO 864.00
2	TI 810.00
3	LA 720.00
4	SO 648.00
5	FA 576.00
6	MI 540.00
7	RE 486.00
8	DO 432.00
9	TI 405.00
10	LA 360.00
11	SO 324.00
12	FA 288.00
13	MI 270.00
14	RE 243.00
15	DO 216.00
16	TI 202.50
17	LA 180.00
18	SO 162.00
19	FA 144.00
20	MI 135.00
21	RE 121.50

**S  
M  
A  
L  
L  
  
S  
U  
B  
U  
L  
A  
T  
E**

## THE CHORD

The structure produced by the three initializing octaves of the universe reveals that, for an octave's ascension, two octaves must begin at the ascending octave's vibrations, MI and SO. In an ascending octave, the notes DO, MI, and SO represent the trinity of forces necessary for ascension. In a musical octave, the notes DO, MI, and SO, when played together, form a chord: if the DO is a C, then DO, MI, and SO form the chord C-Major; if the DO is a G, then DO, MI, and SO form the chord G-Major, and so forth.

2ND SHOCK OCTAVE		1ST SHOCK OCTAVE		AFFIRMING OCTAVE
DO <b>24</b>				
TI 22.5				
LA 20	→	DO <b>20</b>		
		TI 18.75		
SO 18				
		LA 16.666		
FA 16	→	→ → →	→	DO <b>16</b>
MI 15		SO 15		TI 15
RE 13.5				
		FA 13.333		LA 13.333
		MI 12.5		
DO <b>12</b>	←	← ← ←	←	SO 12
		RE 11.25		
				FA 10.666
		DO <b>10</b>	←	MI 10
				RE 9
				DO <b>8</b>

**In a descending octave**, the notes DO, LA, and FA--the three forces--stand in the ratios: 12, 10, and 8 (at **24**, **20**, and **16** in the diagram). Therefore, the three initializing octaves of the Universe at DO, LA, and FA also stand in the ratios: 12, 10, and 8.

**In an ascending octave**, the notes DO, MI, and SO--the same three forces--stand in the ratios: 8, 10, and 12 (at **8**, **10**, and **12** in the diagram). Note: The ascending octave (8) must *initiate shock octaves* at 10 and 12.

Octaves cosmically stand at the greater ratio (12), and therefore descend, unless--by *accident* or by some *precise special effort*--they are able to conform as the lesser ratio (8)...whereupon, *they attain the possibility of ascension*.

Man is double fortunate. First, he is fortunate that the results of *accidental* ascension over billions of years gave him his **existence**. Second, he is also fortunate that *his existence* **allows for the possibility of consciousness**, which enables him to **personally produce** the aforementioned **precise special effort**; thus...**freeing himself** from the dependency of *accidental* ascension.

This idea of an inner transition, or in other words, the giving up of the higher ratio (12) in order to attain the lesser ratio (8), is repeatedly found in all religious and philosophical writings; in passages about Flesh and Spirit, servants making the best Masters, becoming like little children, losing in order to gain, and so forth.

In fact, all serious-being-students should learn first-hand what it means to subjugate the forces in themselves and attain the inner world harmony that results from maintaining the ratios 8, 10, and 12; which, for each of us, is the resounding DO, MI, and SO in the major chord of our soul. *The way up was the way down!*

With this knowledge we will be able to better understand many other things, one of which is Gurdjieff's discourse regarding the transformation of a "threefold kind of being-food":

## THE DIAGRAM OF NUTRITION

"And so, the three-brained beings of the planet Earth are not only, as we also are, apparatuses for the transformation of the cosmic substances required for the Most Great Trogoautoegocrat with the qualities of all the three forces of the fundamental common-cosmic Triamazikamno, but also, themselves absorbing these substances for transformation from three different sources of independent arisings, have all the possibilities of assimilating besides the substances necessary for the maintenance of their own existence, also those substances which go for the coating and perfecting of their own higher-being-bodies.

"In this manner those three-sourced substances entering their common presences for transformation are, just as for us, a threefold kind of being-food.

“That is to say, those substances which, on the path of their returning evolutionary ascent from the sacred ‘Ashagiprotoëhary’-- i.e., from the last Stopinder of the fundamental Sacred Heptaparashinokh toward the Most Most Holy Protocosmos--were transmitted with the aid of their own planet itself into definite higher corresponding surplanetary formations, and enter into them for further transformation as their ‘first being-food,’ which is their ordinary ‘food’ and ‘drink.’

“But those second-sourced substances which, being obtained from the transformations of their own sun and of all the outer planets of their own solar system and which entered the atmosphere of their planet through the radiations of the latter, enter into them again, just as into us, also for further evolutionary transformation as the ‘second being-food,’ which is their, as they there say, ‘air,’ by which they breathe, and these substances in their air just serve for the coating and maintenance of the existence of their ‘second being-bodies.’

“And, finally, the first-sourced substances which for them as well as for us, are a third kind of being-food, serve both for the coating and for the perfecting of the higher being-body itself.

“Now, my boy, as for the processes themselves of the transformation in the evolutionary and involutory movements of all these cosmic substances by means of just such apparatuses of the Most Great common-cosmic Trogoautoegocrat--as all your favorites also are--then those transformations proceed in them as well as in us and in general in all large and small cosmoses of our common Megalocosmoses, strictly according to those two same chief fundamental cosmic laws, namely, according to the Sacred Heptaparaparashinokh and the Sacred Triamazikamno.

“When these evolving active elements, in their returning ascent from the last Stopinder of the fundamental common-cosmic Sacred Heptaparaparashinokh, enter into the common presences of being-apparatuses as their first being-food, they begin already from the mouth itself--with the help of the processes of the second-grade law Harnelmiatznel, that is, owing to mixture and fusion according to the ‘affinity of vibrations,’ with the active elements which have already evolved in the presences of the beings and have acquired vibrations corresponding to the subsequent Stopinders of the being-

Heptaparaparshinokh--to be gradually changed, and are transmuted this time in the stomach of the beings into definite active elements named 'being-Protoëhary,' which correspond in their vibrations to the ascending fourth Stopinder of the fundamental common-cosmic Heptaparaparshinokh.

"From there, this totality which has the 'gravity center vibration' of being-Protoëhary, passing--thanks again only to the process Harnelmiatznel--over the whole of what is called the 'intestinal tract' and gradually evolving, completely acquires in consequence corresponding vibrations, and is this time completely transmuted in what is called the 'duodenum' into 'being-Defteroëhary.'

"Further, a part of these definite substances of 'being-Defteroëhary' go to serve the planetary body itself and also the local Harnelmiatznel in respect of the newly entering food, but the other part, also by means of a process of Harnelmiatznel of local character, continues its independent evolution and is ultimately transmuted in beings into the still higher definite substances which are called, this time, 'being-Tritoëhary.'

"And this totality of cosmic substances, temporarily crystallized in the common presences of 'beings-apparatuses' which correspond in their vibrations to 'being-Tritoëhary,' have as the gravity-center place of their concentration in the presences of beings the, what is called, 'liver.'

"It is just in this place of the being-Ansanbaluiazar that the lower 'Mdnel-In' of the Sacred Heptaparaparshinokh is located, called the 'mechano-coinciding-Mdnel-In,' and therefore the substances of the being-Tritoëhary cannot, only owing to the process 'Harnelmiatznel,' independently evolve further.

"Well then, owing to that change in the general functioning of the primordial common-cosmic sacred law of Heptaparaparshinokh, this totality of substances named 'being-Tritoëhary' can in the given case evolve further from this state only with the help of forces coming from outside.

"That is why in this case, if this totality of substances of 'being-Protoëhary' does not receive foreign help from outside for its

further evolution in the common presences of the beings, then both this totality and all the definite centers of gravity of the being-Ansanbaluiazar crystallized up to it always involve back again into those definite cosmic crystallizations from which they began their evolution.

“For this help coming from outside, Great Nature in the given case most wisely adapted the inner organization of beings in such a manner that the substances which had to enter into the common presences of beings for the coating and feeding of their second being-bodies Kesdjan, namely, that totality of cosmic substances which your favorites call air, might at the same time serve as just such a help coming from outside for the evolution of the substances of the first being-food.

“The active elements which compose this second being-food or air, and which enter into the presences of beings also for evolution through this second being-food, beginning from the nose of beings, gradually evolve with the co-operation of various processes of Harnelmiatznel of local character, and are also transmuted this time in the what are called ‘lungs’ of beings into Protoëhary, but into Protoëhary called ‘Astralnomonian-Protoëhary.’

“And then the substances of this ‘Astralnomonian-Protoëhary,’ entering into the presences of beings for their own evolution and having still in themselves, according to the Sacred Heptaparaparshinokh, all the possibilities of evolving from their centers of gravity by the process of Harnelmiatznel alone, mix with the totality of substances of the first being-food which have already evolved up to the third Stopinder of the Sacred being-Heptaparaparshinokh, and further evolve together, and thus help these substances of the first being-food to pass through the lower ‘mechano-coinciding-Mdnel-In’ and to be transmuted into other definite substances, into ‘being-Tetartoëhary,’ and the ‘Astralnomonian-Protoëhary’ itself is transmuted into the substances named ‘Astralnomonian-Defteroëhary.’

“And so...the ordinary first being-food is thus gradually transmuted in beings into definite substances called ‘being-Tetartoëhary,’ which have in beings, just as of course in your favorites, as the central place of their concentration both of what are called the ‘hemispheres of their head-brain.’

“Further, a part of this being-Tetartoëhary from both hemispheres of their head-brain goes unchanged to serve the planetary body of the given being, but the other part having in itself all the possibilities for independent evolution, continues to evolve without any help coming from outside; and mixing again by means of the process Harnelmiatznel with previously formed higher substances already present in the beings, it is gradually transmuted into still higher definite being-active-elements called ‘Piandjoëhary.’

“And these substances have as the central place of their concentration in beings the, what is called, ‘Sianoorinam’ or, as your favorites call this part of their planetary body, the ‘cerebellum,’ which in beings is also located in the head.

“Just these same substances in beings, according to the fifth deflection of the Sacred Heptaparaparshinokh, have the free possibility of giving, in the manifestations of the common presences of three-brained beings, results not similar but ‘opposite to each other.’

“That is why, in respect of these being-substances, the beings themselves must always be very, very much on their guard in order to avoid undesirable consequences for their entire whole.

“From the cerebellum of beings a part of these definite substances also goes to serve the planetary body itself, but the other part, passing in a particular way through the ‘nerve nodes’ of the spine and the breast, is concentrated in the beings of the male sex, in what are called ‘testicles’ and in the beings of the female sex in what most of your favorites call ‘ovaries,’ which are the place of concentration in the common presences of beings of the ‘being-Exioëhary,’ which is for the beings themselves their most sacred possession. You should know that this particular way mentioned is called ‘Trnlva.’

“Only after this are the cosmic substances which enter beings-apparatuses for the purpose of evolution, that is for the possibility of passing the lower Mdnel-In of the fundamental common-cosmic ‘exchange of substances,’ transformed into that definite totality of cosmic substances--which transformation is the lot of all beings in general and also of your contemporary three-brained beings who breed on the planet Earth in particular, for the

automatic justification of the sense and aim of their existence, and this totality of cosmic substances is everywhere called 'Exioëhary.'

"And so, my boy, this totality of their first being-food which results from the evolution in these beings-apparatuses, corresponds with its vibrations to the last Stopinder of the being-Heptaparaparshinokh, and according to the particularity of this Stopinder, it enters the 'higher-intentionally-actualizing-Mdnel-In' of the law of Heptaparaparshinokh; and in order to transform completely into new higher substances and in order to acquire vibrations corresponding to the vibrations of the next higher vivifyingness, namely, corresponding to the fifth Stopinder of the fundamental process of the common-cosmic Sacred Heptaparaparshinokh, it inevitably requires just that foreign help which is actualized only in the presences of the three-brained beings exclusively owing to those factors mentioned by me more than once and which are manifested in the 'being-Partkdolg-duty,' that is, owing to just those factors which our COMMON FATHER CREATOR ENDLESSNESS consented to foreordain to be the means by which certain of the Tetartocosmoses--as a final result of their serving the purposes of the common-cosmic Iraniranumange--might become helpers in the ruling of the enlarged World and which factors also until now serve as the sole possible means for the assimilation of the cosmic substances required for the coating and perfecting of the higher being-bodies and which we at the present time call 'conscious labors' and 'intentional suffering.'" <sup>15</sup>

We have taken the "Diagram of Nutrition" from P.D. Ouspensky's book, *The Fourth Way*, page 219, and have modified it with the mathematics of the three octaves we have been discussing (see page 85). In addition, we have added the completing notes, Do and Fa, for the octaves of food and impressions. Observing the diagram--with these mathematical additions--will help us to understand the necessity of "shock octaves", and gives us insight as to *why* the production of "higher substances" is necessary for the transubstantiation of our soul.

Food enters through the upper story and begins its primary transformation in the stomach. Passing into the blood it goes to the lungs where food enters its "mechano-coinciding-Mdnel-In". Here, at MI-120, it receives an "automatic shock" and is oxygenated by air (the "second being-food"). Food then continues, in its process of transformation, up to TI-180, where upon reaching the

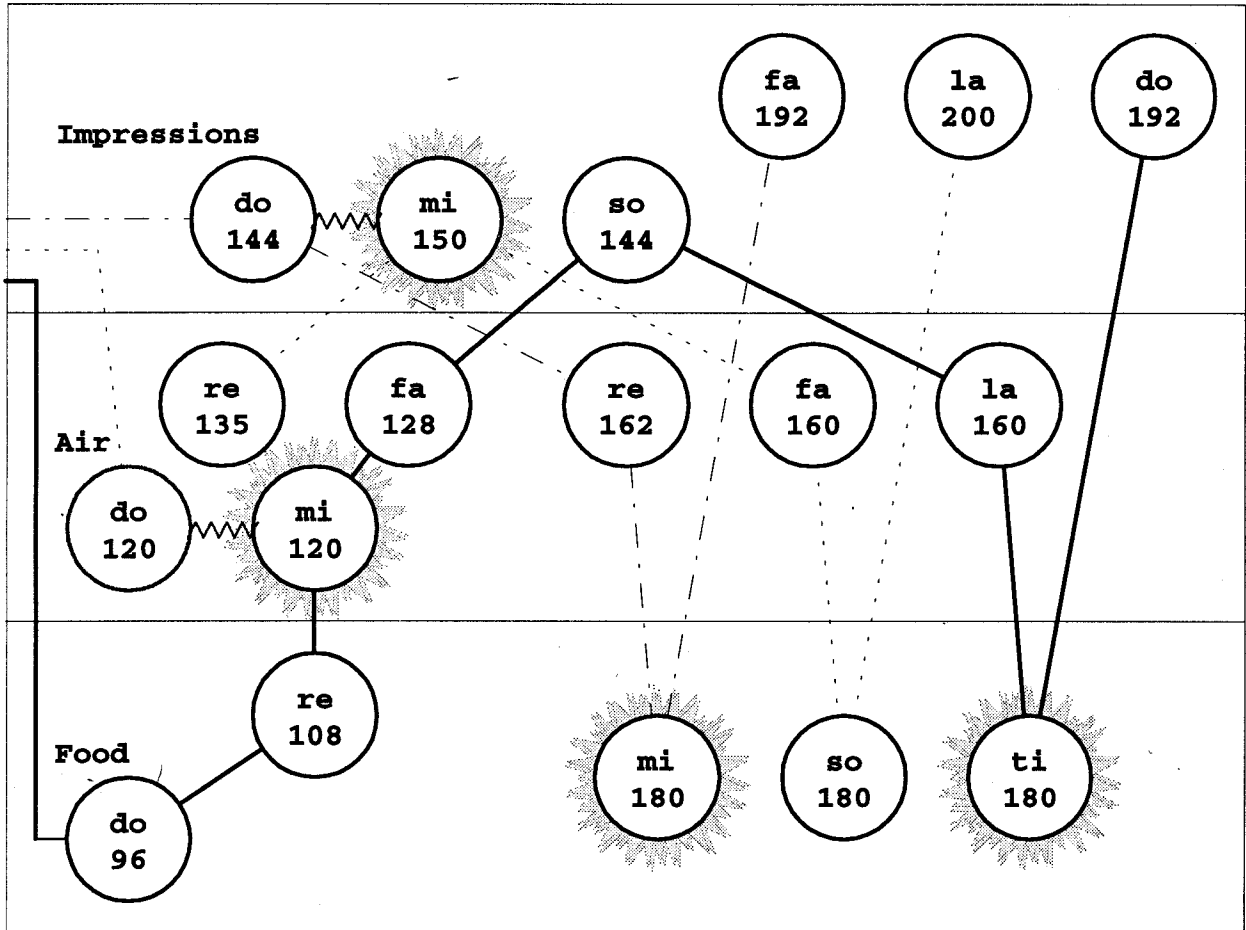

“intentionally-actualized-Mdnel-In”, food stops again and cannot evolve further without the help of, what is called, the “second conscious shock”.

In the meantime, air--through the process of transformation--has reached the vibration MI-150 (its “mechano-coinciding-Mdnel-In”) where it has stopped. No “automatic shock” is provided to help air past this interval! Air requires, what is called, the “first conscious shock” in order to complete its process of transformation and attain the vibration LA-200.

The “first conscious shock” occurs at the point where impressions enter (the “third being-food”) but since we are not conscious they stop. For impressions to evolve further they also require the “first conscious shock”. In addition, if impressions do receive the “first conscious shock” they stop again upon reaching the note MI-180 (their “mechano-coinciding-Mdnel-In”). Notice that *impressions’* “mechano-coinciding-Mdnel-In” is in **mathematical alignment** with *food’s* “intentionally-actualized-Mdnel-In”. Here, both octaves, in order to overcome this common interval and enter the higher half of the Man-Angel major oscillation, require the aforementioned “second conscious shock”. Note: The transformation

of food begins in, what Gurdjieff calls, “the ascending fourth Stopinder” (Fa-So), in the lower half of some major oscillation (page 81); and ends with a possibility of achieving “the next highest vivifyingness”, the “fifth Stopinder” (So-La), the upper half of this major oscillation (page 84). Question: What oscillation could have its lower half as the food octave and its higher half beyond? Answer: The Man-Angel major oscillation!

In *The Fourth Way*, page 221, Ouspensky calls the “first conscious shock”--“**self remembering**”; and the second conscious shock--“**the transformation of negative emotions into positive emotions**”. We could continue on this subject but that would take us outside the boundaries of the third striving--*the conscious striving to know ever more and more concerning the laws of World-creation and World-maintenance*. However, as promised earlier, we will prove in chapter seven, unequivocally, “why the Mi-Fa and Ti-Do intervals exist”; at that time, you will clearly understand *why* shocks are necessary to overcome them.

## THE ENNEAGRAM

We began this publication by examining Gurdjieff’s symbol of the Enneagram. Deciphering it allowed us to understand the changing of the two fundamental laws. In this chapter we examined how the way up was the way down. Considering this knowledge, we can better understand the symbol of the Enneagram (see page 87). The bottom two points of the triangle “do not align with the notes of the octave”; but rather, fall between La-So and Fa-Mi. Why are the points between La-So and Fa-Mi? Simple. The Enneagram represents both, “the way down” and “the way up”. In a descending octave, octaves “always” begin at the notes La and Fa--the forces. In an ascending octave, octaves “must” begin at the notes Mi and So--the shocks. On the way down, if we shift the bottom two points of the triangle to the left, the points align with La and Fa--the forces. On the way up, if we shift the bottom two points of the triangle to the right, the points align with Mi and So--the shocks. However, the Enneagram is only a symbolic representation of the laws. In the real world you cannot “shift” things so easily...

THE REASON:

In a descending octave *the forces* are “always” at La and Fa.

THE PROBLEM:

In an ascending octave *the forces* are “always” at La and Fa.

TO OVERCOME THESE FORCES...TO ASCEND  
...WE MUST BEGIN "SHOCK OCTAVES"  
AT MI AND SO!

THE SYMBOLIC ENNEAGRAM

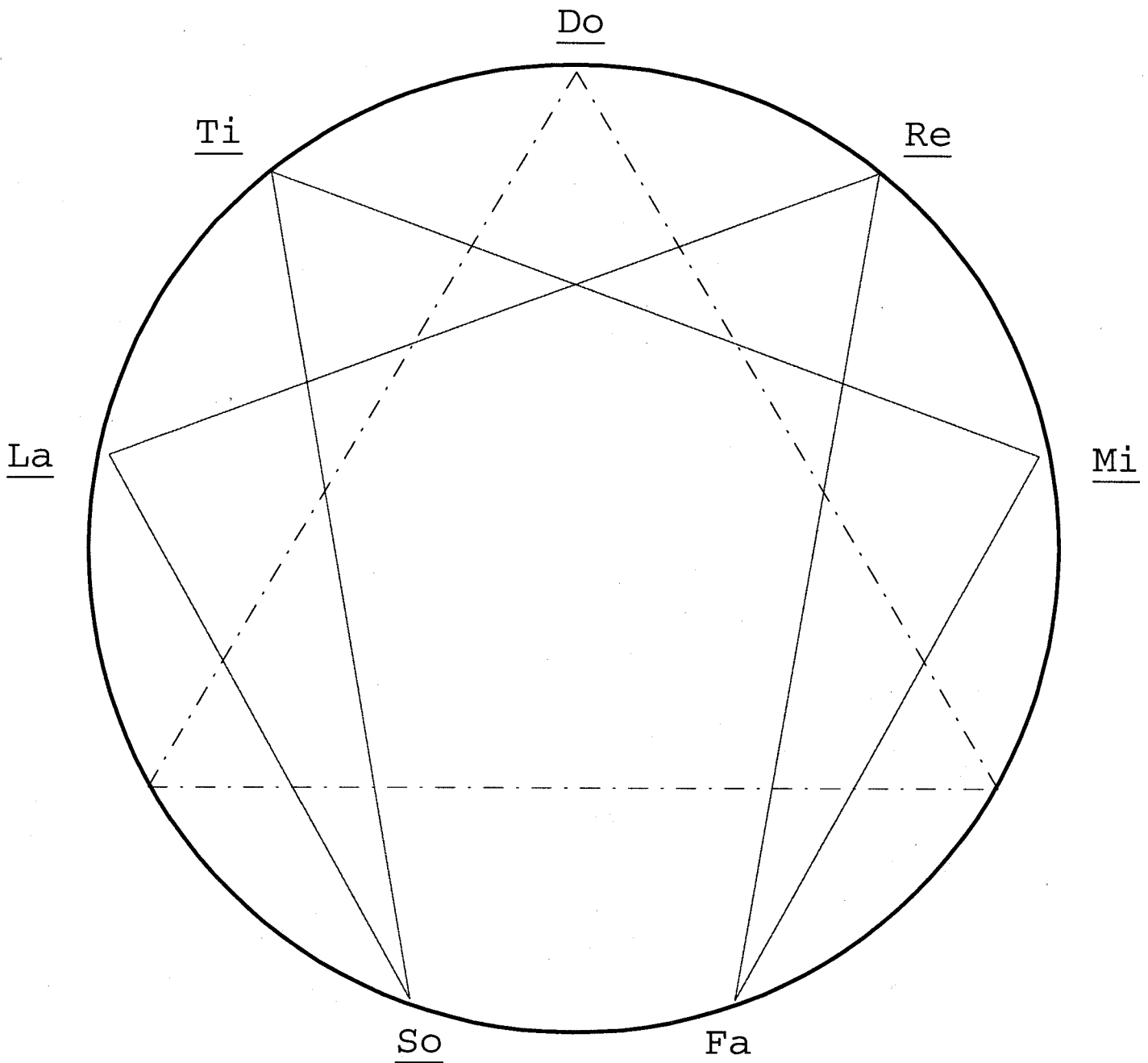

Now, let us examine the Enneagram as it “actually is”. We call it the Diatonic Enneagram because the circumference is divided diatonically; i.e., the forces and the notes are diatonic. Here you can see that if you do not *initiate* the “shock octaves” (Do-2 and Do-3), at Mi and So, you are going to run smack-dab into the forces at Fa and La, which will ultimately deny your ascension....Shocking, isn't it!

## THE DIATONIC ENNEAGRAM

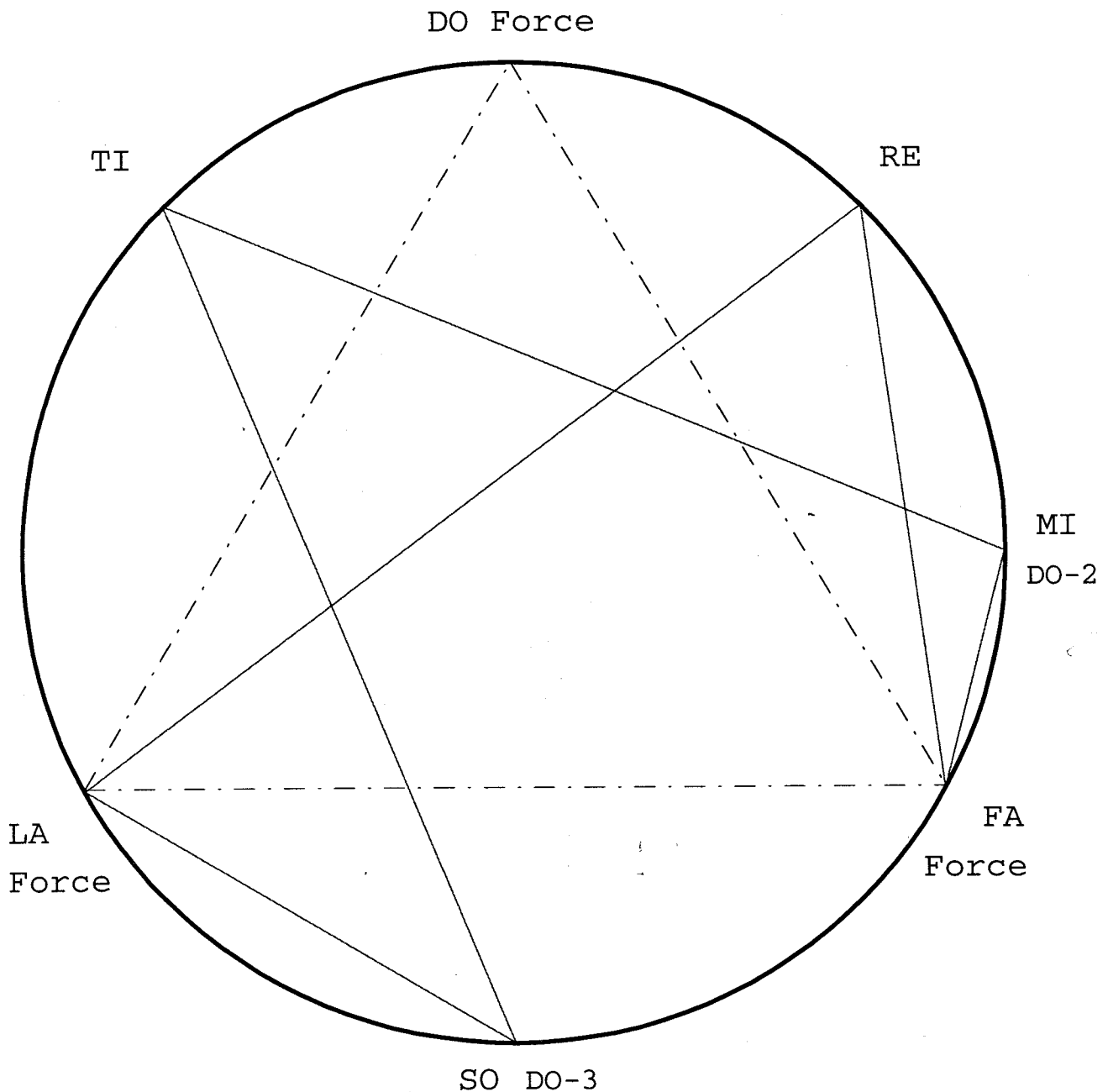

# CHAPTER FIVE WORKSHEET

1. Calculate a Diatonic Enneagram for each of the three forces, and incorporate the common enneagram and triangle lines into the symbol of the affirming enneagram.

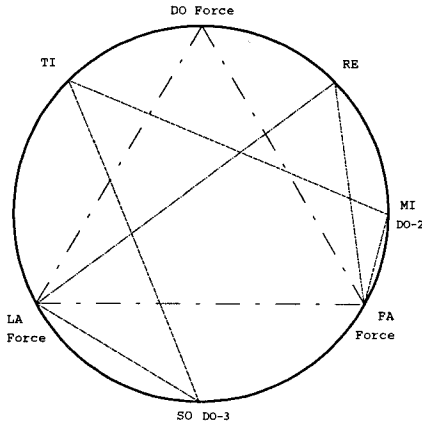

Hint: Make the enneagram (on the left) the octave of the affirming force, DO-96 to DO-192; then, write in all of the notes from the first shock and second shock octaves (page 75) that match vibrations with one of the vibrations in this enneagram. Draw the DO-FA triangle lines, affirming force to denying force, for the two shock octaves. Tip: Their denying forces will now be at the triangle points LA and DO. **Notice that all three triangle points are now denying forces.** Note: In addition, a (1-4-2-8-5-7-1) enneagram line, from one of the shock octaves, will also appear in this enneagram.

2. Calculate the octaves that stand at the ratios 10 and 8 to the octave of 576; and also calculate the octaves that stand at the ratios 10 and 12 to the octave of 288.

NOTE: ALL ANSWERS WILL BE WHOLE NUMBERS.

DO =  
 TI =  
 LA =  
 SO =  
 FA =  
 MI =  
 RE =

DO =  
 TI =  
 LA =  
 SO =  
 FA =  
 MI =  
 RE =

12  
DO = 576  
 TI =

10  
 LA = DO =  
 MI = TI =  
 SO =

DO =  
 12

DO =  
 10

DO = 288  
 8

8  
 LA = DO =  
 MI = TI =  
 FA = LA =  
 MI = SO =  
 RE =  
 DO = FA =  
 MI =  
 RE =  
 DO =

**LA**

## CHAPTER SIX

# THE UNIVERSAL COSMIC WEAVE

Now it is time for us to complete the structure of the Universe. To do this we must decipher two clues.

*The First Clue:*

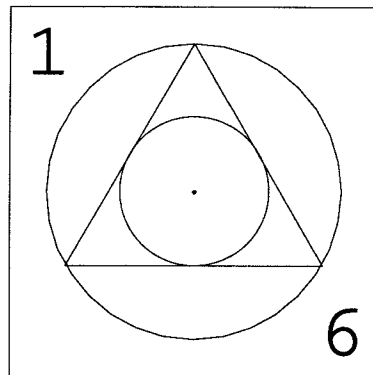

ABSOLUTE

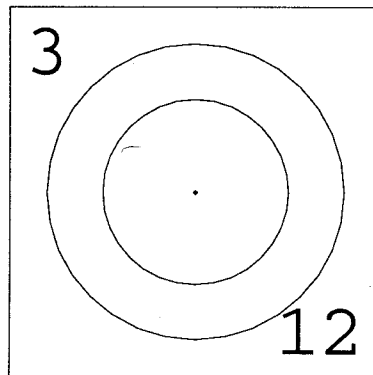

ETERNAL-  
UNCHANGING

Concealed in the top two squares of Gurdjieff's "Diagram of Everything Living" we can find multiple representations of the laws of World-creation and World-maintenance; that is, there is not just one dog...but an entire pack!

[In one square] "...he put figures 3 and 12 and two circles, each with a point at their centers, and called it the 'Eternal Unchanging,' and in the next square he put the figures 1 and 6; he put a circle in the middle and in this circle a triangle containing another circle with a point at its center and called it the 'Absolute.'" <sup>16</sup>

We shall begin our excavations in the symbol of the Absolute.

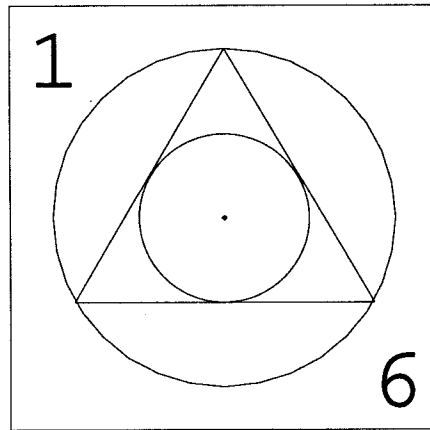

The symbol is divided into two distinct areas: one area, within the inner circle; and the other area, between the inner circle and the outer circle. The area within the inner circle contains, at its center, a single point. This represents Oneness; God; or in Gurdjieff's cosmology, the Absolute. Here, the three forces are **“united”**. The area between the inner circle and the outer circle contains a triangle. This represents the Trinity; or in Gurdjieff's cosmology, the Holy Sun Absolute. Here, the three forces are **“separated”**.

*The Second Clue:*

“And so, my dear boy, our COMMON FATHER CREATOR ALMIGHTY, having then in the beginning changed the functioning of both these primordial sacred laws, directed the action of their forces from within the Most Holy Sun Absolute into the space of the Universe, whereupon there was obtained the what is called ‘Emanation-of-the-Sun-Absolute’ and now called, ‘Theomertmalogos’ or ‘Word-God.’”<sup>17</sup>

This clue indicates we are to draw a new circle around the Holy Sun Absolute to represent the “space of the Universe”. We now have a new symbol, *three circles and a triangle* (see page 93): the inner circle with the single point is the Absolute, the middle circle with the triangle is the Holy Sun Absolute, and the outer circle with the empty space is the Universe. This *transitional symbol* contains the symbol of the Absolute and the symbol of the Eternal Unchanging. This becomes clear if we conceptualize the outer circle in the symbol of the Absolute, as the inner circle in the symbol of the Eternal Unchanging.

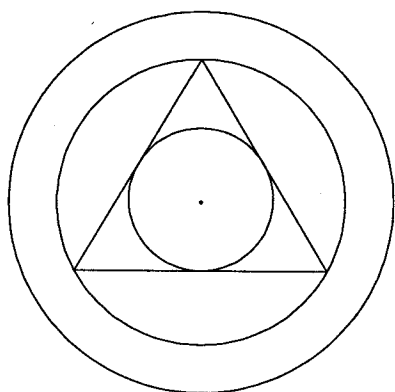

We can complete the transition, from “*being the symbol of the Absolute*” to “*becoming the symbol of the Eternal Unchanging*”, by shrinking the inner circle (the circle of the Absolute) down to a single point; thus, eliminating the area “where the three forces are united”, and giving exclusive focus to the area “where the three forces are separated”. Now, since we no longer need to distinguish the difference between “where the three forces are united” and “where the three forces are separated”, we can eliminate the triangle from the symbol.

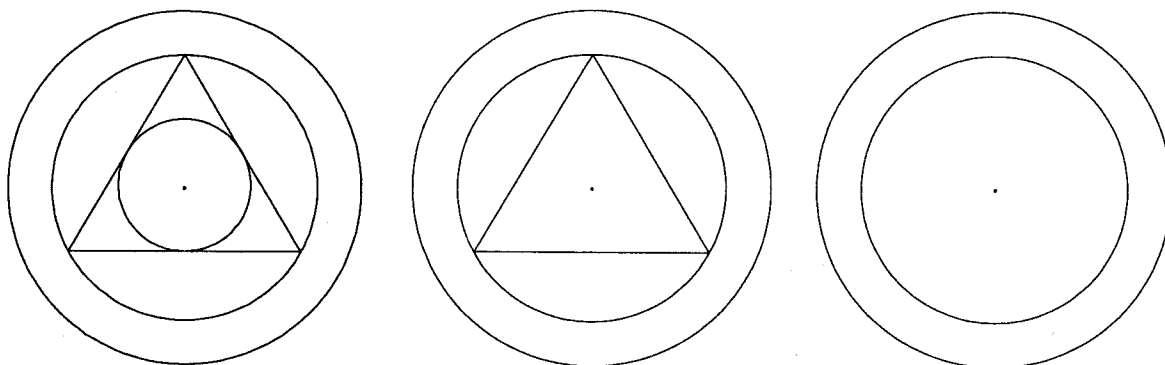

This act of “shrinking the inner circle down to a single point” gives us the symbol of the Eternal Unchanging--two circles with two points in the center. Again, these two points are: the inner circle in the symbol of the Absolute reduced to a point of singularity; and the original point within it.

Another one of the keys to the symbol of the Eternal Unchanging comes from its name. Previously we learned from Gurdjieff, in chapter one, about our Endlessness’ desire to keep the Holy Sun Absolute from diminishing in volume. With this idea in mind we can conceive the notion that the Universe we find ourselves in is a support system for the Holy Sun Absolute. Its purpose: to assure that the Holy Sun Absolute maintains the position of eternal unchanging. Now, to view the entire chain of events in the process of creation, we will return to the transitional symbol of *three circles and a triangle*.

The symbol with three circles has 4 BOUNDARIES.

The four boundaries divide the symbol into 3 SEGMENTS:

(1) the *inner* segment (point to inner circle) is the **Absolute**.

(2) the *middle* segment (inner circle to middle circle) is the **Holy Sun Absolute**.

(3) the *outer* segment (middle to outer circle) is the **Universe**.

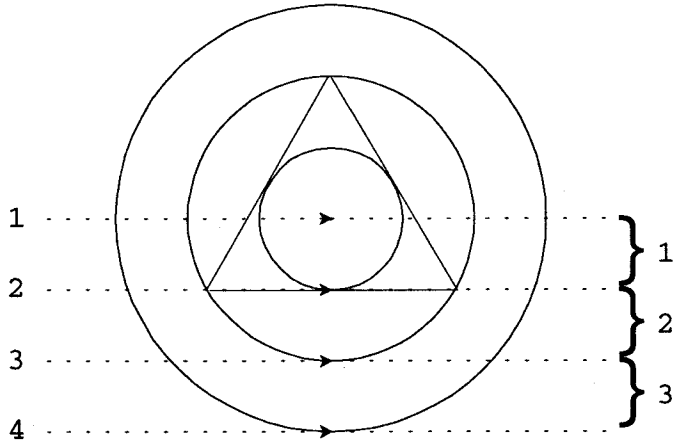

4 BOUNDARIES ◊ 3 SEGMENTS

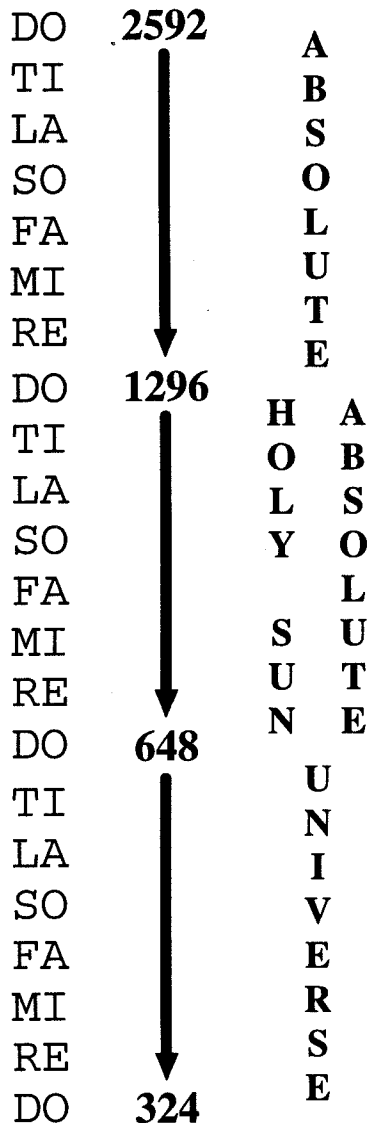

Each segment is a totality and represents a “whole phenomenon”; and remember, since any whole phenomenon can be calculated as an octave, we should begin by configuring the three segments as *three consecutive, descending octaves*.

In the Absolute, the inner segment (2592 to 1296), the three Holy forces are at each place.

Note: With all three forces at each place, the three forces become one octave; therefore...

A “SINGLE OCTAVE” PORTRAYS THE ABSOLUTE.

### THE ABSOLUTE

DO	2592	7/7
TI	2406	6/7
LA	2221	5/7
SO	2036	4/7
FA	1851	3/7
MI	1666	2/7
RE	1481	1/7
DO	1296	0/7

The Absolute remains in its primordial form; that is, *flowing by even sevenths*.

In the Holy Sun Absolute, the middle segment (1296 to 648), the three Holy forces are separated...and configured diatonically. Notice that the octave originating at the Absolute (1296) defines the Holy Sun Absolute as Force-1. The octaves of Force-2 (1080) and Force-3 (864) begin in the Holy Sun Absolute, but during their diatonic halving they descend below 648--leaving the Holy Sun Absolute--and penetrating into the Universe (648 to 324).

## THE HOLY SUN ABSOLUTE

FORCE-1	FORCE-2	FORCE-3
DO 1296		
TI 1215		
LA 1080 -----	DO 1080	
	TI 1012	
SO 972		
	LA 900	
FA 864 -----		DO 864
MI 810	SO 810	TI 810
RE 729		
	FA 720	LA 720
	MI 675	
DO 648		SO 648

Postulation: *If diatonic Forces are in alignment with the LA and FA of Force-1...then there must be...“corresponding, diatonic Forces” in alignment with the LA’s and FA’s of Force-2 and Force-3.*

We find this same idea repeated more than once in Gurdjieff’s writings:

**EACH NEW SOMETHING ESTABLISHES FOR ITSELF  
ITS OWN LAW OF SEVEN AND ITS OWN LAW OF THREE.**

*The progression of any force will follow the diatonic Law of Octaves; and its ensuing, diatonic vibrations ( La and Fa ) will manifest as the second and third forces of its “Trinity”!*

With this knowledge...we can uncover three, additional forces (octaves) that come into existence in the middle segment--the Holy Sun Absolute.

We have already diatonically calculated the three separated forces: 1296, 1080, and 864. Now we must calculate a new diatonic force coming into existence at 900 vibrations (it corresponds to the LA of Force-2); we will label it Force-4. Another diatonic force--Force-5--is calculated at 720 vibrations (it corresponds to the FA of Force-2 and the LA of Force-3). Force-6 is diatonically calculated at 750 vibrations (it corresponds to the LA of Force-4).

## THE HOLY SUN ABSOLUTE

FORCE-1   FORCE-2   FORCE-3   FORCE-4   FORCE-5   FORCE-6

DO 1296					
TI 1215					
LA 1080	---	DO 1080			
		TI 1012.			
SO 972					
		LA 900	-----	DO 900	
FA 864	-----	DO 864			
				TI 843.	
MI 810	SO 810	TI 810			
				LA 750	-----
					DO 750
RE 729					
		FA 720	---	LA 720	-----
					DO 720
					TI 703.
		MI 675		SO 675	TI 675
DO 648			SO 648		

**These six octaves (forces) are the only octaves that come into existence in the middle segment--the Holy Sun Absolute.**

The “coming into existence” of three additional forces in the Holy Sun Absolute can be subtly found in the second clue, where Gurdjieff says “...directed the action of their forces...”. This action of the three separated forces, is precisely the act of:

- Force-2 manifesting the creation of Force-4
- Force-2 and Force-3 manifesting the creation of Force-5
- Force-4 manifesting the creation of Force-6

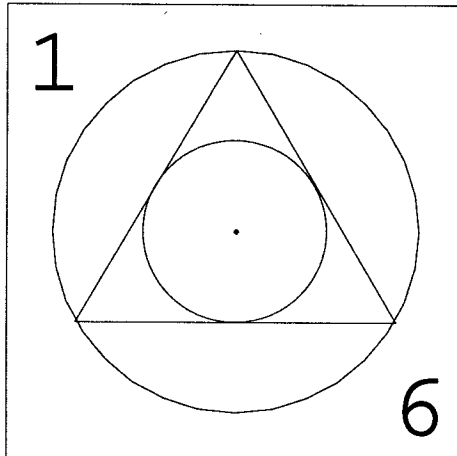

Returning to Gurdjieff's symbol of the Absolute, we find the numbers **1** and **6**. These numbers reflect the **single octave** that portrayed the Absolute and the **six octaves** created in the Holy Sun Absolute. This completes the structure of the inner segment (the Absolute); and the middle segment (the Holy Sun Absolute). The only segment left to complete is the outer segment (the Universe). Before we complete the outer segment, let us first finish Gurdjieff's remarkable dissertation, as there are many other "dogs" to expose; and it will be beneficial for us to review a few passages...passages, that laid the foundation upon which we now stand!

## **THE GURDJIEFF TREATISE**

“And so, in the beginning as I have already told you, our Most Most Holy Sun Absolute was maintained by the help of these two primordial sacred laws; but then these primordial laws functioned independently, without the help of any forces whatsoever coming from outside, and this system was still called only the ‘Autoegocrat.’

“And so, our ALL-MAINTAINING ENDLESSNESS decided to change the principle of the system of the functionings of both of these fundamental sacred laws, and, namely, HE decided to make their independent functioning dependent on forces coming from outside.

“And so, in consequence of the fact that for this new system of functioning of the forces which until then maintained the existence of the Most Most Holy Sun Absolute, there were required outside of the Sun Absolute corresponding sources in which such forces could arise and from which they could flow into the presence

of the Most Most Holy Sun Absolute, our ALMIGHTY ENDLESSNESS was just then compelled to create our now existing Megalocosmos with all the cosmoses of different scales and relatively independent cosmic formations present in it, and from then on the system which maintained the existence of the Sun Absolute began to be called Trogoautoegocrat.

“Our COMMON FATHER OMNI-BEING ENDLESSNESS, having decided to change the principle of the maintenance of the existence of this then still unique cosmic concentration and sole place of HIS most glorious Being, first of all altered the process itself of the functioning of these two primordial fundamental sacred laws, and HE actualized the greater change in the law of the sacred Heptaparaparshinokh.

“These changes in the functioning of the sacred Heptaparaparshinokh consisted in this, that in three of its Stopinders HE altered the, what are called ‘subjective actions’ which had been until then in the Stopinders, in this respect, that in one HE lengthened the law conformable successiveness; shortened it in another; and in a third, disharmonized it.

“And, namely, with the purpose of providing the ‘requisite inherency’ for receiving, for its functioning, the automatic affluence of all forces which were near, HE lengthened the Stopinder between its third and fourth deflections.

“This same Stopinder of the sacred Heptaparaparshinokh is just that one, which is still called the ‘mechano-coinciding-Mdnel-In.’

“And the Stopinder which HE shortened, is between its last deflection and the beginning of a new cycle of its completing process; by this same shortening, for the purpose of facilitating the commencement of a new cycle of its completing process, HE predetermined the functioning of the given Stopinder to be dependent only upon the affluence of forces, obtained from outside through that Stopinder from the results of the action of that cosmic concentration itself in which the completing process of this primordial fundamental sacred law flows.

“And this Stopinder of the sacred Heptaparaparshinokh is just that one, which is still called the ‘intentionally-actualized-Mdnel-In.’

“As regards the third Stopinder, then changed in its ‘subjective action’ and which is fifth in the general successiveness and is called ‘Harnel-Aoot,’ its disharmony flowed by itself from the change of the two aforementioned Stopinders.

“This disharmony in its subjective functioning, flowing from its asymmetry so to say in relation to the whole entire completing process of the sacred Heptaparaparshinokh, consists in the following:

“If the completing process of this sacred law flows in conditions, where during its process there are many ‘extraneously-caused-vibrations,’ then all its functioning gives only external results.

“But if this same process proceeds in absolute quiet without any external ‘extraneously-caused-vibrations’ whatsoever, then all the results of the action of its functioning remain within that concentration in which it completes its process, and for the outside, these results only become evident on direct and immediate contact with it.

“And if however during its functioning there are neither of these two sharply opposite conditions, then the results of the action of its process usually divide themselves into the external and the internal.

“Thus from that time, the process of actualization began to proceed in the greatest as well as in the smallest cosmic concentrations with these Stopinders of this primordial sacred law of Heptaparaparshinokh changed in this way in their subjective actions.

“I repeat, my boy: Try very hard to understand everything that will relate to both these fundamental cosmic sacred laws, since knowledge of these sacred laws, particularly knowledge relating to the particularities of the sacred Heptaparaparshinokh, will help you in the future to understand very easily and very well all the second-grade and third-grade laws of World-creation and World-existence. Likewise, an all-round awareness of everything concerning these sacred laws also conduces, in general, to this, that three-brained beings irrespective of the form of their exterior coating, by becoming capable in the presence of all cosmic factors not depending on them and arising round about them--both the personally favorable as well as the unfavorable--of pondering on the sense of existence, acquire

data for the elucidation and reconciliation in themselves of that, what is called, 'individual collision' which often arises, in general, in three-brained beings from the contradiction between the concrete results flowing from the processes of all the cosmic laws and the results presupposed and even quite surely expected by their what is called 'sane-logic'; and thus, correctly evaluating the essential significance of their own presence, they become capable of becoming aware of the genuine corresponding place for themselves in these common-cosmic actualizations.

"In short, the transmutation in themselves of an all-round understanding of the functioning of both these fundamental sacred laws conduces to this, that in the common presences of three-brained beings, data are crystallized for engendering that Divine property which it is indispensable for every normal three-brained being to have and which exists under the name of 'Semooniranoos'; of this your favorites have also an approximate representation, and they call it 'impartiality.'

"And so, my dear boy, our COMMON FATHER CREATOR ALMIGHTY, having then in the beginning changed the functioning of both these primordial sacred laws, directed the action of their forces from within the Most Holy Sun Absolute into the space of the Universe, whereupon there was obtained the what is called 'Emanation-of-the-Sun-Absolute' and now called, 'Theomertmalogos' or 'Word-God.'

"For the clarity of certain of my future explanations it must here be remarked that, in the process of the creation of the now existing World, the Divine 'Will Power' of our ENDLESSNESS participated only at the beginning.

"The subsequent creation went on automatically, of its own accord, entirely without the participation of His Own Divine Will Power, thanks only to these two changed fundamental primordial cosmic laws.

"And the process itself of creation proceeded then in the following successiveness:

"Thanks to the new particularity of the fifth Stopinder of the sacred Heptaparaparshinokh, these emanations issuing from the Sun Absolute began to act at certain definite points of the space of the

Universe upon the prime-source cosmic substance Etherokrilno from which, owing to the totality of the former and the new particularities of the sacred primordial laws, certain definite concentrations began to be concentrated.

“Further, thanks to these factors and also to their own laws of Heptaparaparshinokh and Triamazikamno which had already begun to arise in these definite concentrations with their action upon each other, everything which had to be gradually begun to be crystallized in these concentrations, and as a result of all this, those large concentrations were obtained which exist also until now and which we now call ‘Second-order-Suns.’

“When these newly arisen Suns had been completely actualized and their own functionings of both the fundamental laws had been finally established in them, then in them also, similarly to the Most Most Holy Sun Absolute, their own results began to be transformed and to be radiated, which, together with the emanations issuing from the Most Most Holy Sun Absolute into the space of the Universe, became the factors for the actualization of the common-cosmic fundamental process of the sacred law of Triamazikamno, and that is to say:

“The Most Most Holy Theomertmalogos began to manifest itself in the quality of the third holy force of the sacred Triamazikamno; the results of any one of the newly arisen Second-order-Suns began to serve as the first holy force; and the results of all the other newly arisen Second-order-Suns in relation to this mentioned one newly arisen Sun, as the second holy force of this sacred law.

“Thanks to the process of the common-cosmic sacred Triamazikamno thus established in the space of the Universe, crystallizations of different what is called ‘density’ gradually began to be formed around each of the Second-order-Suns out of that same prime-source Etherokrilno, and grouping themselves around these newly arisen Suns, new concentrations began to take form, as a result of which more new Suns were obtained, but this time ‘Third-order-Suns.’

“These third-order concentrations are just those cosmic concentrations which at the present time are called planets.

“At this very place in the process of the first outer cycle of the fundamental sacred Heptaparaparshinokh, namely, after the formation of the Third-order-Suns or planets, just here, owing to the changed fifth deflection of the sacred Heptaparaparshinokh, which as I have already said is now called Harnel-Aoot, the initially given momentum for the fundamental completing process, having lost half the force of its vivifyingness, began in its further functioning to have only half of the manifestation of its action outside itself, and the other half for itself, i.e., for its very own functioning, the consequences of which were that on these last big results, i.e., on these said Third-order-Suns or planets, there began to arise what are called, ‘similarities-to-the-already-arisen.’

“And as after this, surrounding conditions of actualizations were everywhere established corresponding to the manifestation of the second particularity of the fifth Stopinder of the fundamental sacred Heptaparaparshinokh, therefore from then on the actualization of the fundamental outer cycle of the sacred Heptaparaparshinokh ceased, and all the action of its functioning entered forever into the results already manifested by it, and in them there began to proceed its inherent permanent processes of transformation, called ‘evolution’ and ‘involution.’”<sup>18</sup>

One of the many, significant points in this exposition is the introduction of the “Harnel-Aoot”--the Stopinder that was disharmonized. The Harnel-Aoot, as identified by Gurdjieff, is fifth in general successiveness [ascending order], that is, the Stopinder between SO and LA. Later, we shall examine *how* and *why* this Stopinder plays such a significant role in the creation of the universe. For now, by continuing with the postulation **that every force is an octave...and every octave creates two additional forces**, we can mathematically diagram the octaves that lawfully arise in the outer segment--**the Universe**. We call it: *The Universal Cosmic Weave*. First, we complete the calculations; then, we arrange the octaves chronologically, i.e., *in the order of their creation*--numbering them: 1 through 19. This reveals thirteen new octaves coming into existence in the Universe (sub-labeled 1-13). Note: Only twelve of these thirteen octaves accomplish the filling of the “intentionally-actualized-Mdnel-In”, i.e., the sounding of the note TI. In Gurdjieff’s cosmology the Do-Ti interval, in a descending octave, is filled by the vibration of the Do itself. Later we shall see that the filling of the Ti-Do interval is precisely what gives the initial impetus for becoming “a higher octave”. The thirteenth octave has *no* TI-DO interval and is, therefore, incapable of ascension!



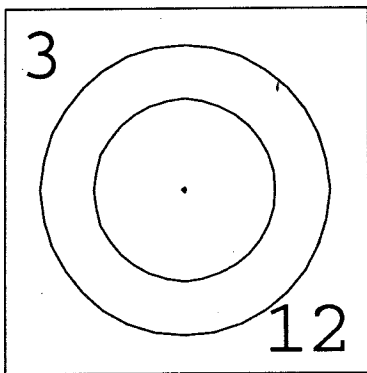

In the symbol of the Eternal Unchanging, Gurdjieff placed the numbers 3 and 12. The number 3 reflects the *three new forces* that came into being in the Holy Sun Absolute (after the three separated forces), i.e., the forces we previously labeled 4, 5, and 6 (before listing the forces in chronological order). The number 12 reflects the *twelve complete forces* that come into being in the Universe.

### THE DIG IS DONE; LET THE POSTMORTEMS BEGIN!

We will start by examining the structure of the 19 octaves. Here we find a *unique, mathematical progression* revealed during their formation. It starts with one octave, the Absolute. This one octave creates two octaves. These two octaves

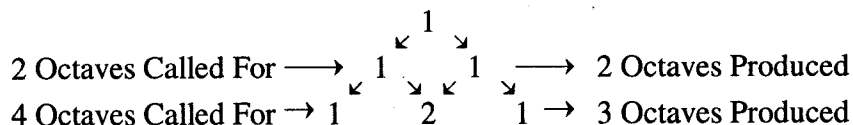

create two additional octaves, giving us a total of four octaves. However, *two of these four octaves occur at the same vibration so only three octaves are actually produced*. If we continue this progression, we see that for each level the number of octaves *called for* **doubles**, while the actual number of octaves *produced* **only** increases by one.

### OCTAVES' STRUCTURE PASCAL'S TRIANGLE

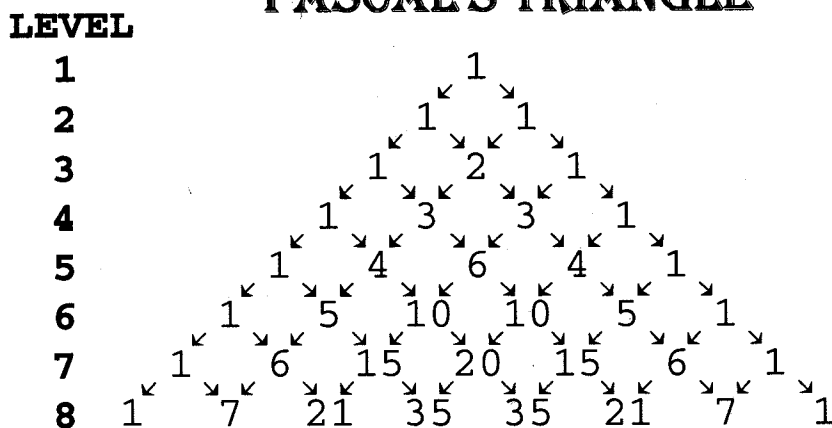

The *mathematics* of this triangular structure was first discovered by Pascal, hence it is known as "*Pascal's Triangle*". Of course, we now realize...**Pascal's Triangle is created by the diatonic structure of the Universe!**

The structure produced by the formation of outer octaves is incredible, and “*the incredible*” has just begun....If we plot the 19 octaves’ points of creation, *the octaves* occur from right to left and create a series of rows within Pascal’s triangle.

### 19 OCTAVES’ POINTS OF CREATION

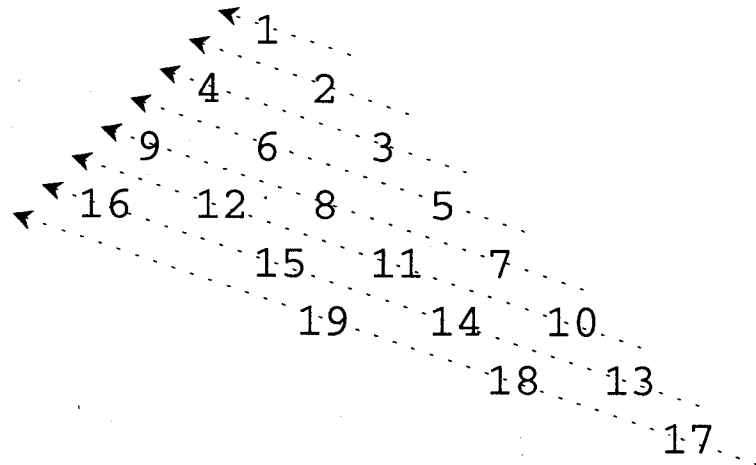

Returning to the diagram of *Pascal’s Triangle* and totaling the numbers that are found in these rows, we find another mathematical series fundamental to Life, the *Fibonacci Series* (the series 1, 1, 2, 3, 5, 8, 13, 21, 34, 55, etc.), which was first formulated by Leonardo Fibonacci. We can recognize the spiral shaped, Fibonacci series in nature: in sea shells, flower designs, pineapple husks...everywhere!

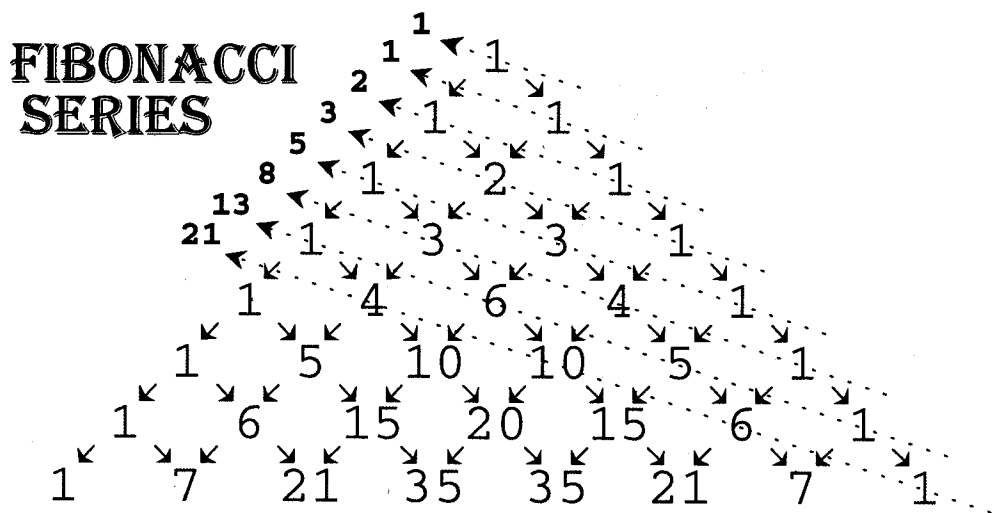

Remember, “everything”--including the Universe--results from *the diatonic structure of three forces*, i.e., diatonic forces, creating additional diatonic forces, and so on; and the *mathematical configuration* of these diatonic forces *explains* “why” Pascal’s Triangle and the Fibonacci Series are so prevalent in the Universe!

We should **explore** the *mathematical factors* that produce this mathematical configuration. In chapter one we discussed the formula for calculating descending octaves (page 6); in a descending octave, LA is **5/6** of DO and FA is **2/3** of DO. In the diagram, the FA's are calculated to the left; and the LA's, to the right.

## BOUNDARIES OF CREATION

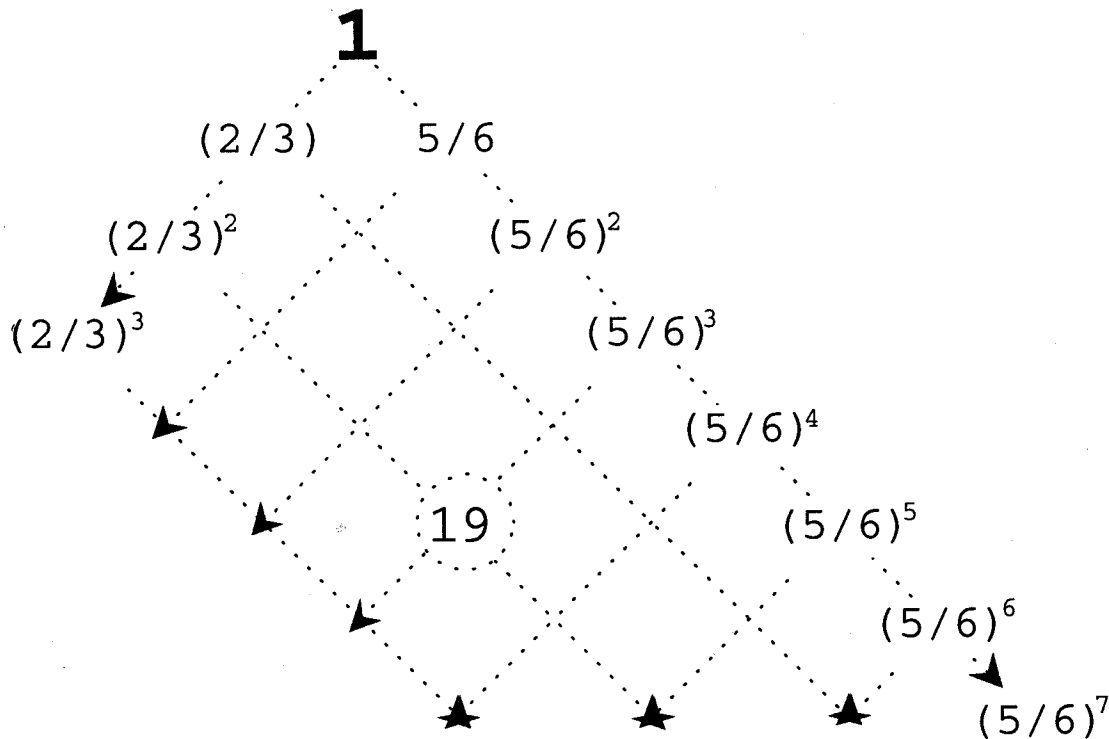

The factors for **one boundary** are the **powers of 2/3, up to (2/3)<sup>3</sup>**

*[calculating the FA's down the left side of Pascal's Triangle]*

The factors for **the other boundary** are the **powers of 5/6, up to (5/6)<sup>7</sup>**

*[calculating the LA's down the right side of Pascal's Triangle]*

The factors for the quantities within...are simply the product of these two intersecting boundaries, e.g., the 19th octave is where  $(2/3)^2$  intersects with  $(5/6)^3$ ; therefore, the factors for the 19th octave are  **$(2/3)^2$  times  $(5/6)^3$** .

In Gurdjieff's cosmology (page 102), the fundamental outer cycle ceases when it reaches the bottom of the Universe. In chapter seven we shall examine this idea in detail. At present, it should be easy to reconcile that even the flow of creation--which emanates outward from the oneness of the Absolute--is governed by boundaries that are reflective of the Law of Three and the Law of Seven.

**THE CONFIGURATION OF CREATION PROCEEDS ACCORDING TO THE POWERS OF TWO CONSTANTS, ENDING AT A POINT WHERE ONE CONSTANT HAS BEEN RAISED TO THE POWER OF 3 AND THE OTHER CONSTANT TO THE POWER OF 7.**

“We must return to the Law of Three. You will remember how it was explained that everything that happens is the result of the action of three forces and that two forces by themselves cannot produce any effect. I will try to connect this idea with the Ray of Creation.”

“The Absolute is World 1, for the three forces in it make one. By his own will and consciousness the Absolute creates worlds. It is all intentional there and each force in it occupies each place. This is incomprehensible to us. In the next world, World 3, there are the same three forces, only they are already divided. These three forces again produce worlds of which we take one, but this World 6 is different from World 3 which is in contact with the Absolute, for it is already mechanical. World 6 has three forces from the preceding world and three of its own. The next world, World 12, has three forces from the world of the second order, six from the world of the third order and three of its own. The next world, World 24, has twenty-four forces, the one after forty-eight forces and the last ninety-six forces.”

World 1 Absolute	1
World 3 All Worlds	3
World 6 All Suns	6 (3 + 3)
World 12 Sun	12 (3 + 6 + 3)
World 24 All Planets	24 (3 + 6 + 12 + 3)
World 48 Earth	48 (3 + 6 + 12 + 24 + 3)
World 96 Moon	96 (3 + 6 + 12 + 24 + 48 + 3)

“These figures refer to the number of laws governing each world. The greater the number of laws, the harder it is to change anything. For instance, man lives on earth, which is under forty-eight laws. He himself is under many more laws, but even these forty-eight laws make it very difficult for him to change anything because every little thing is governed by these laws. Fortunately not all of the laws under which man lives are obligatory for him, so he may escape from some of them, and his possibility of evolution is fundamentally connected with escaping from certain laws.”<sup>19</sup>

Gurdjieff's discourse, regarding the increasing number of laws each world is subjected to, is revealed by the structure of outer octaves. Note: Later we shall see that Gurdjieff *singles out the sixteenth octave* as being the beginning of what he calls "similarities-to-the-already-arisen". Realizing that the sixteenth octave starts another stage allows us to **remove it from this stage**--the 19 octaves.

## PROGRESSION OF FORCES

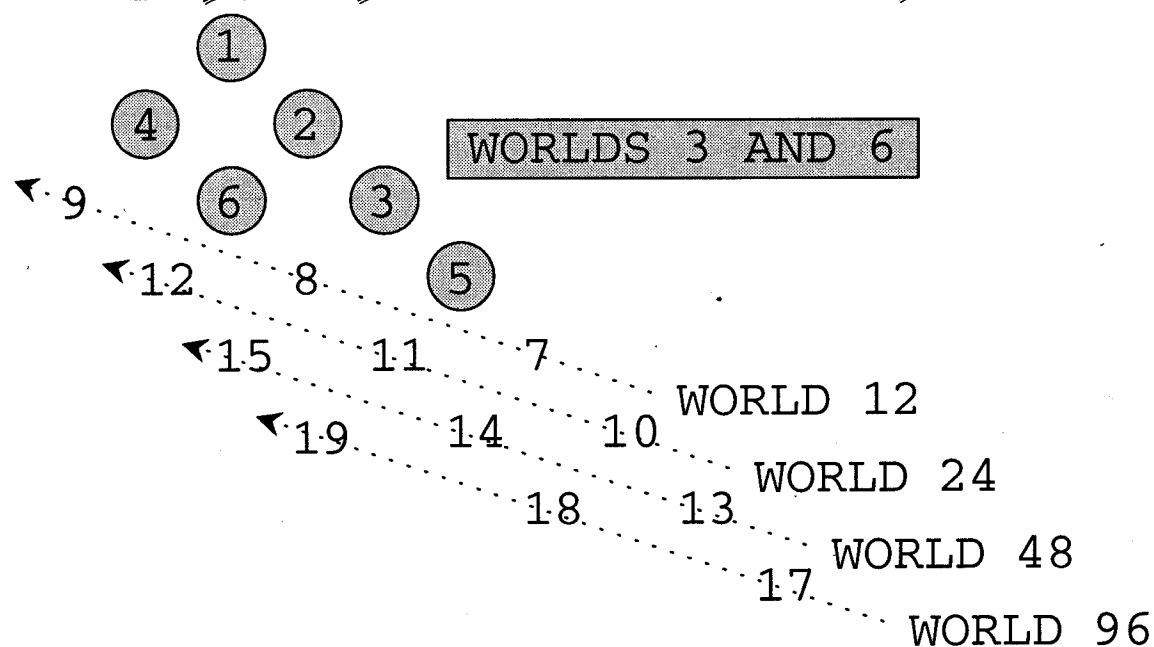

This structure, "the 19 octaves' points of creation" (page 105), with the *sixteenth octave removed*, reveals Gurdjieff's progression of Forces. The three separated forces and the three octaves created in the Holy Sun Absolute create Worlds 3 and 6. Then, a series of three forces (octaves) comes into being during the formation of each row; the same rows that revealed the *Fibonacci Series*.

Before explaining the *sixteenth octave*, or why the fundamental outer cycle stops at the bottom of the Universe, we must first complete the diagram of outer octaves (see page 109). Aim: to observe **all of the possible interactions** among these 19 octaves' vibrations. Required: "seven diatonic vibrations" for each of the 19 octaves. Solution: compute the "ascending diatonic structure" of octaves *ten through nineteen*. Note: *The tenth octave* can complete an ascending RE in the Universe; *the eleventh octave* can complete an ascending RE and MI; *the twelfth octave*, an ascending RE, MI, and FA; and so forth.

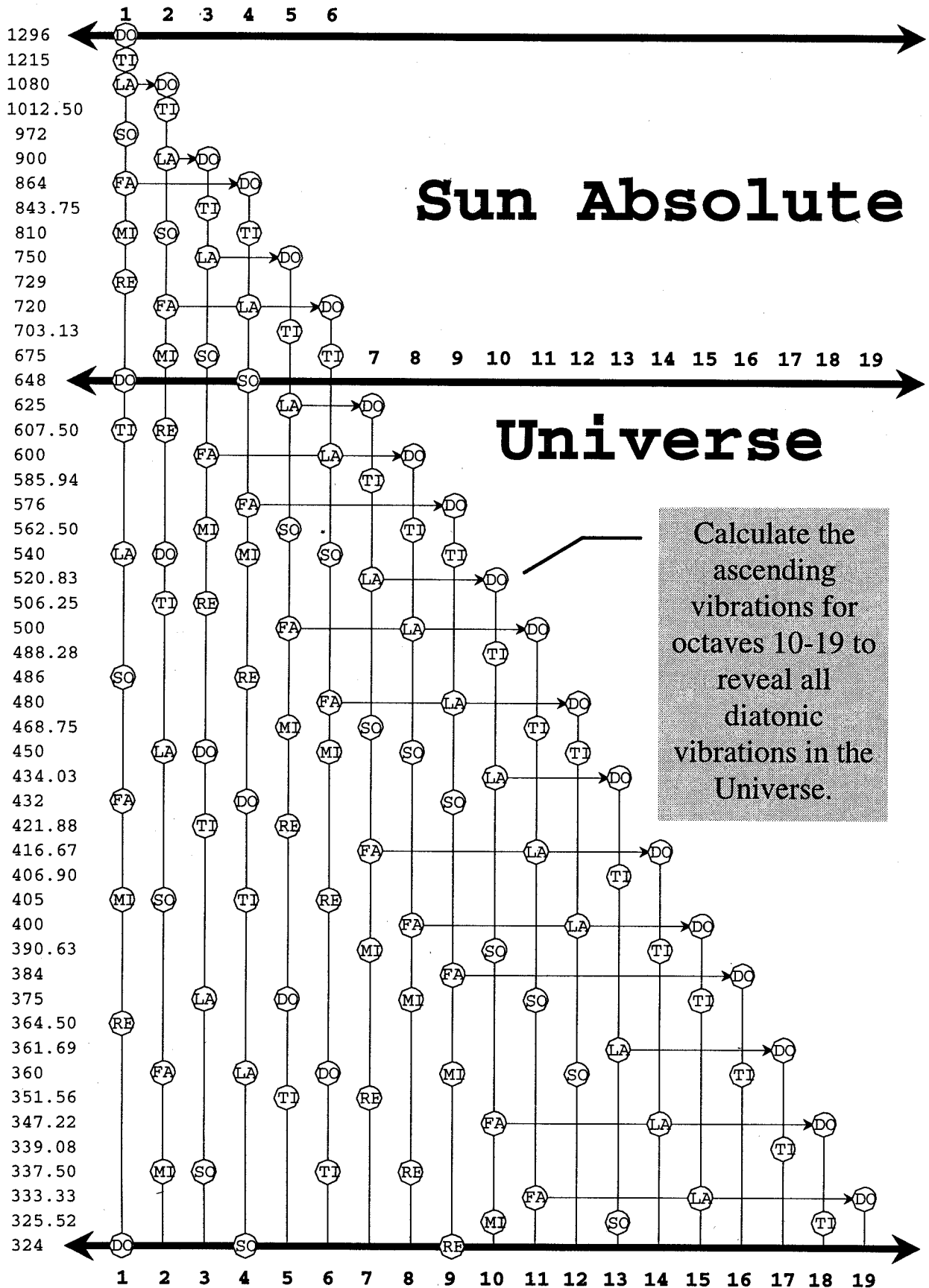

The calculations reveal...that a total of 47 diatonic vibrations comes into existence in the 19 octaves that structure the Universe.

## DIATONIC STRUCTURE OF THE UNIVERSE

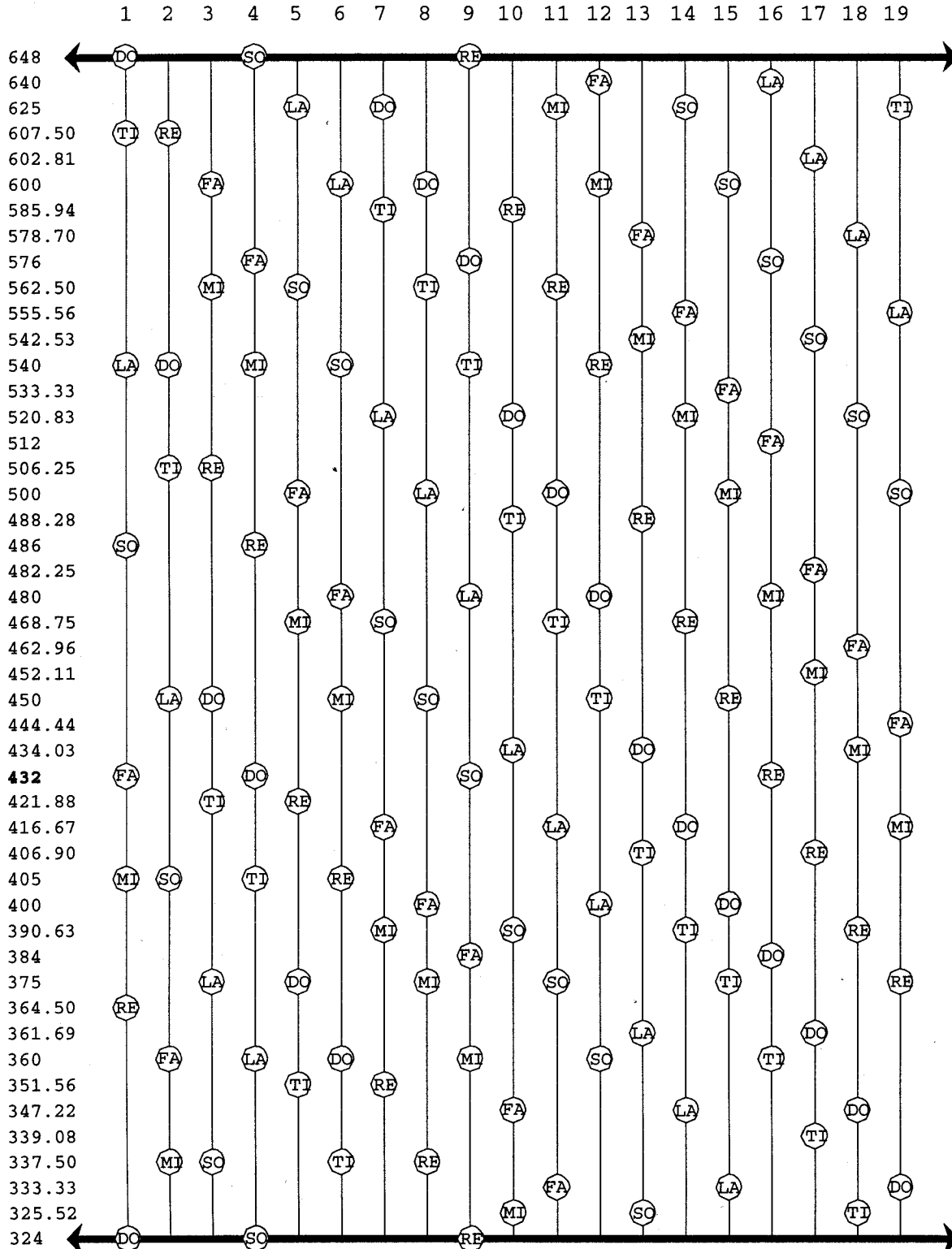

### Supreme Vibrations and Related Octaves

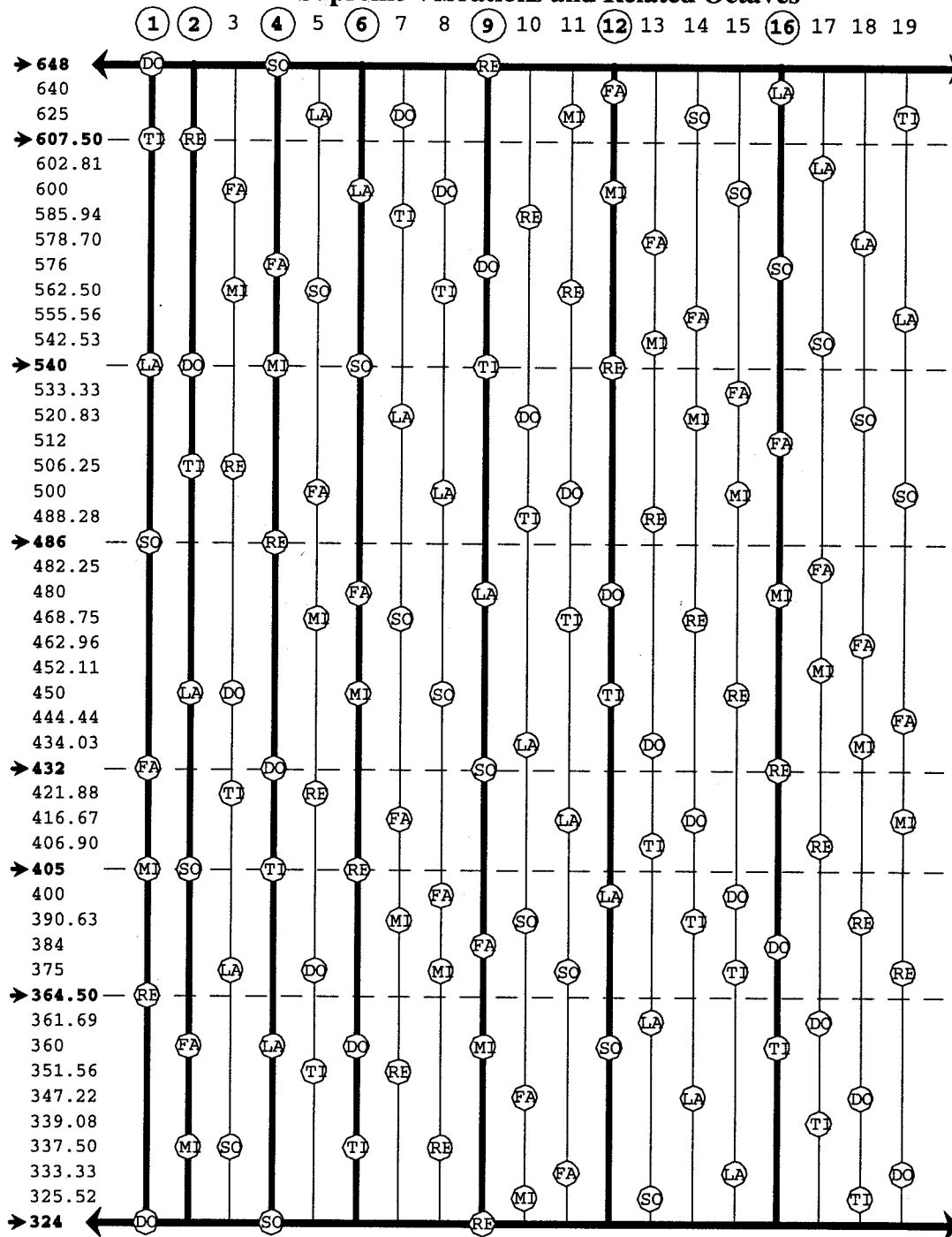

The seven diatonic vibrations in the first octave, that is, the vibrations coming from the Absolute (648 to 324) are obviously the *most vivifying*. We will call them **Supreme Vibrations**. Six other octaves, numbers 2, 4, 6, 9, 12, and 16 also contain Supreme Vibrations. All octaves with Supreme Vibrations we will call **Supreme Octaves**. Removing these Supreme Octaves from the 19 octaves reveals twelve octaves that do not contain Supreme Vibrations.

### Prime Vibrations and Related Octaves

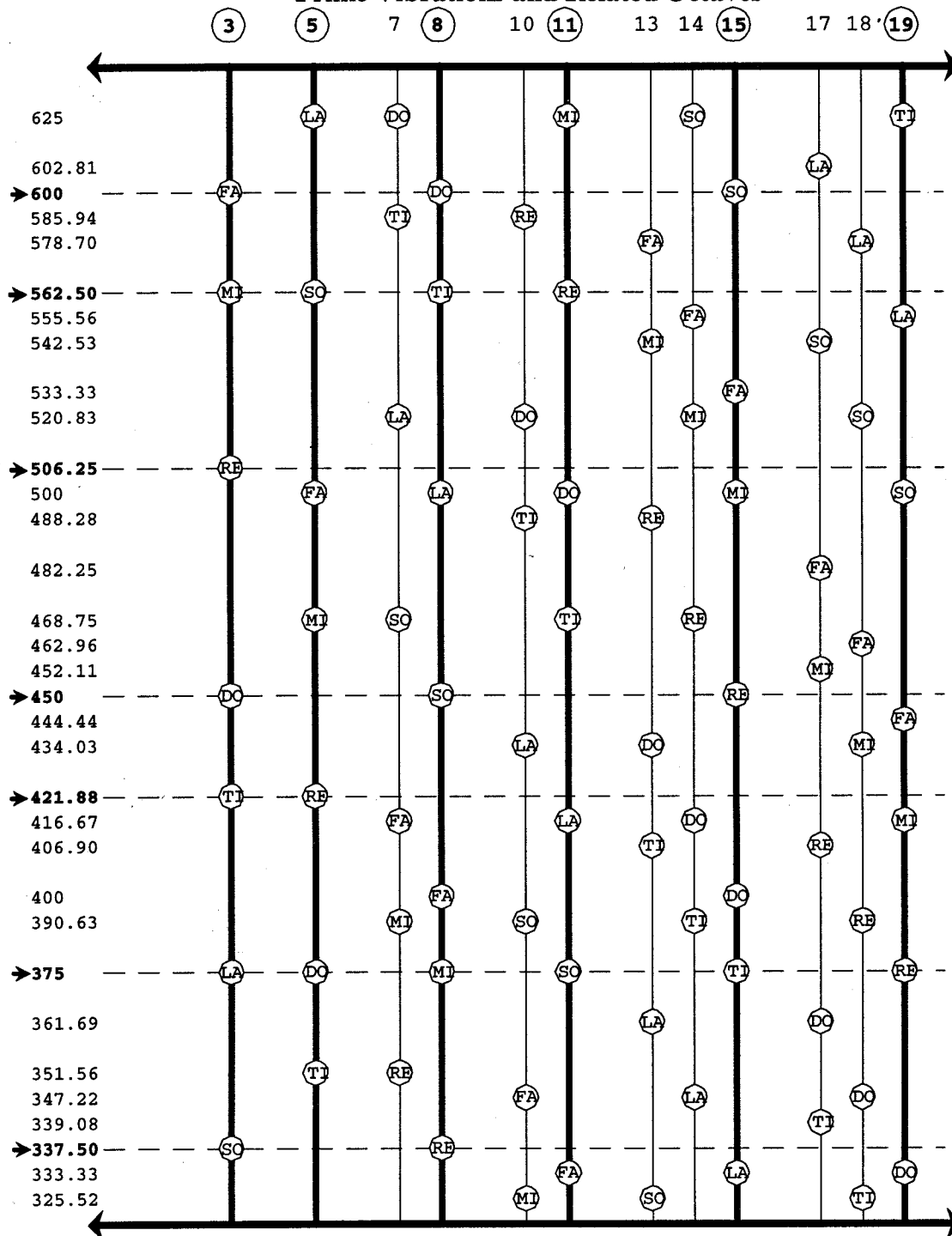

Next, octave number 3 initiates a series of *seven new, diatonic vibrations*. We will call this second series of vibrations **Prime Vibrations**. Five other octaves contain Prime Vibrations, numbers 5, 8, 11, 15, and 19. All octaves with Prime Vibrations we will call **Prime Octaves**. Removing these Prime Octaves reveals six octaves that do not contain either Supreme or Prime vibrations.

## Distant Vibrations and Related Octaves

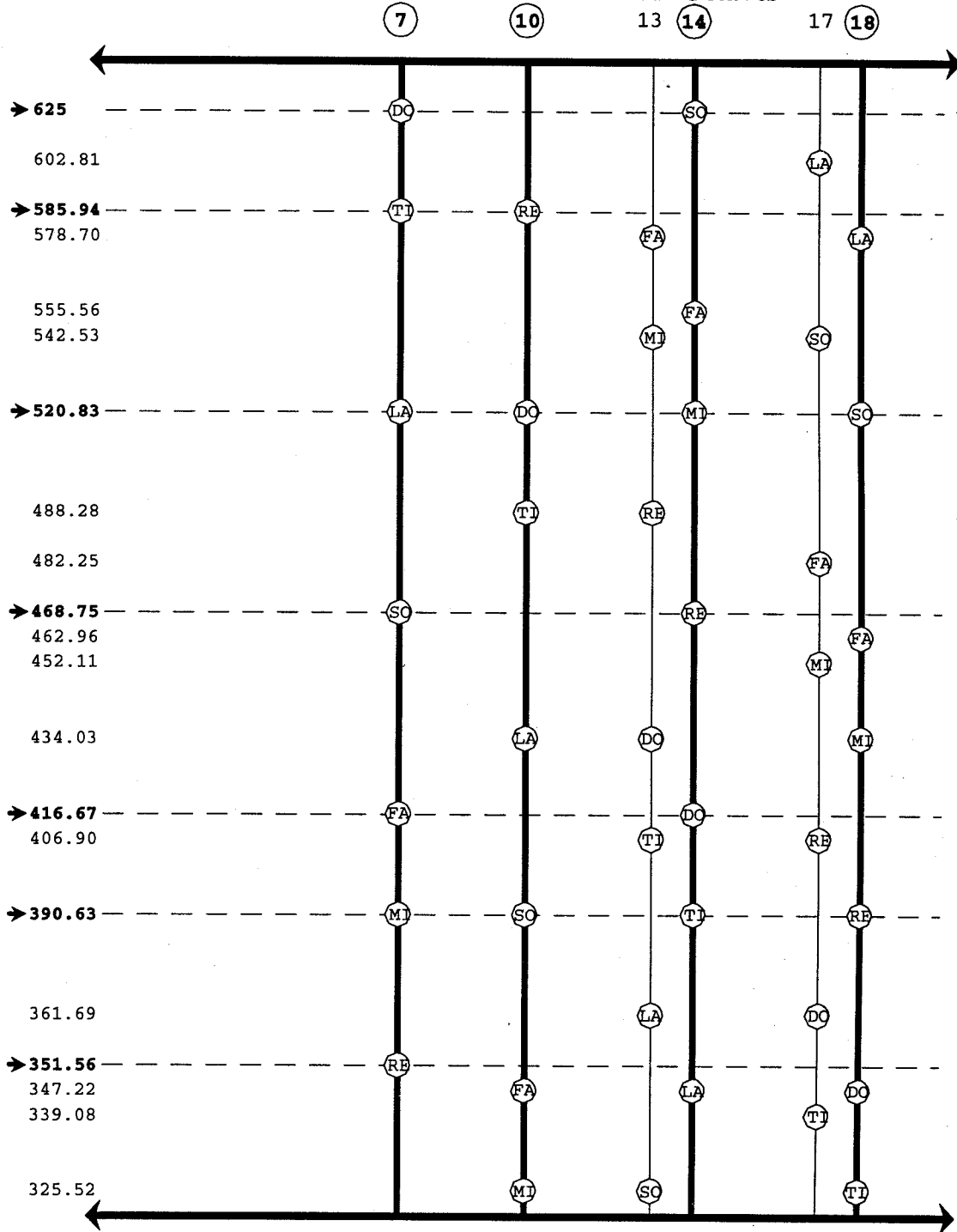

Then, octave number 7 creates another series of *seven new, diatonic vibrations*. We will call this series of vibrations **Distant Vibrations**. Three other octaves contain Distant Vibrations, numbers 10, 14, and 18. Octaves with Distant Vibrations we will call **Distant Octaves**. Removing the Distant Octaves reveals two octaves that do not contain either Supreme, Prime, or Distant vibrations.

## Final Vibrations and Related Octaves

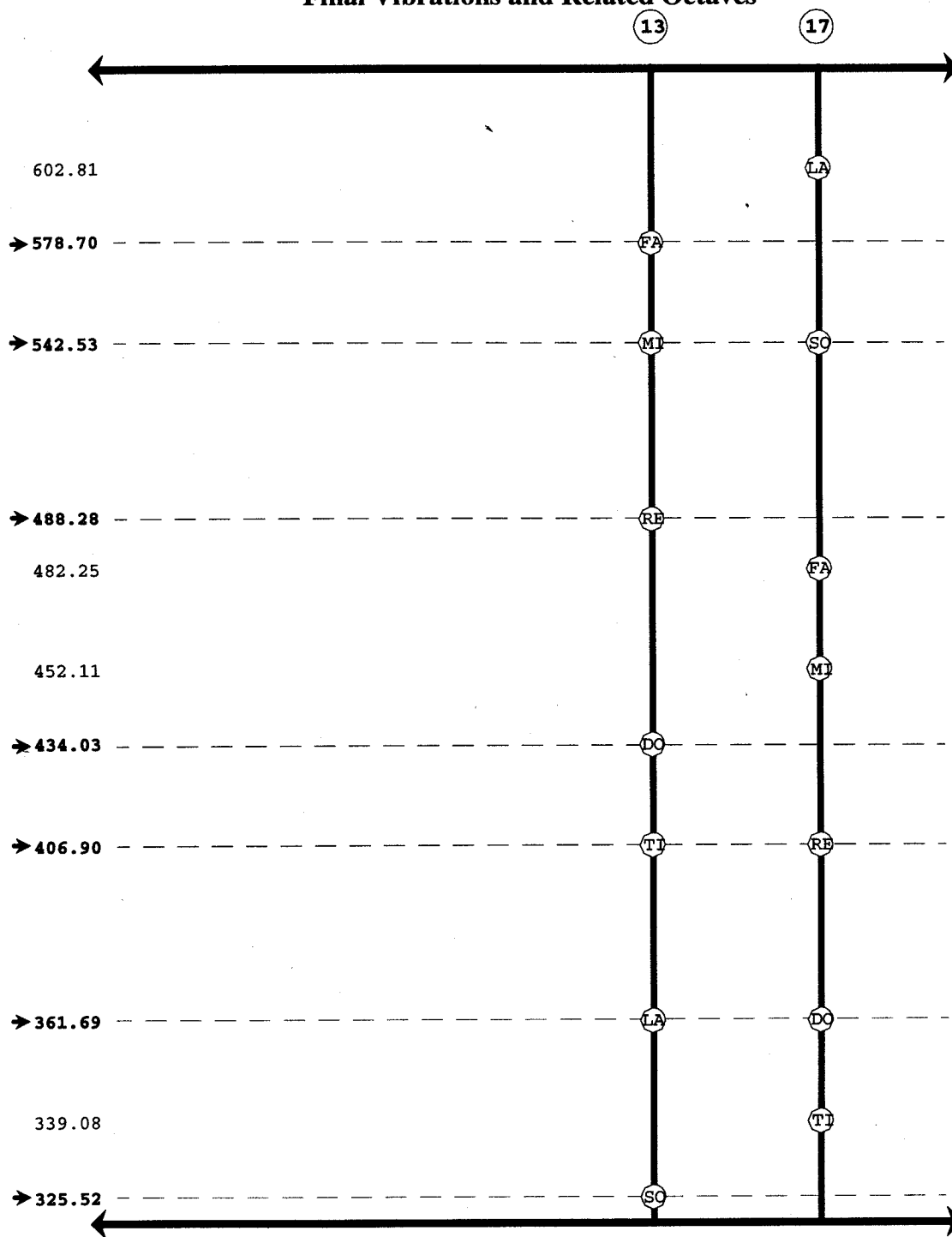

Finally, the 13th octave reveals the fourth and final series of *seven new, diatonic vibrations*. We will appropriately call this series of vibrations **Final Vibrations**. The 17th octave also contains Final Vibrations. All octaves with Final Vibrations we will call **Final Octaves**.

We now have four families: **Supreme, Prime, Distant, and Final**.

**FIRST FAMILY--SUPREME OCTAVES: 1, 2, 4, 6, 9, 12, AND 16.**

**SECOND FAMILY--PRIME OCTAVES: 3, 5, 8, 11, 15, AND 19.**

**THIRD FAMILY--DISTANT OCTAVES: 7, 10, 14 AND 18.**

**FOURTH FAMILY--FINAL OCTAVES: 13 AND 17.**

In order to identify these families we need to relabel the 19 octaves. The first octave in each family should be numbered to reflect the family it begins:

Octave 1 begins the *first* family, the Supreme-family.  
It becomes **1** Supreme.

Octave 3 begins the *second* family, the Prime-family.  
It becomes **2** Prime.

Octave 7 begins the *third* family, the Distant-family.  
It becomes **3** Distant.

Octave 13 begins the *fourth* family, the Final-family.  
It becomes **4** Final.

Each of the remaining family octaves should be numbered consecutively from the first number given to its family.

Supreme Octaves (2, 4, 6, 9, 12, and 16) become:  
2 Supreme, 3 Supreme, 4 Supreme, 5 Supreme, 6 Supreme, etc.

Prime Octaves (5, 8, 11, 15, and 19) become:  
3 Prime, 4 Prime, 5 Prime, 6 Prime, and 7 Prime.

Distant Octaves (10, 14, and 18) become:  
4 Distant, 5 Distant and 6 Distant.

Lastly, Final Octave (17) becomes:  
5 Final.

## OCTAVES IN THE UNIVERSE

Order of Occurrence	Labeled According to Family
1	1 Supreme
2	2 Supreme
3	2 Prime
4	3 Supreme
5	3 Prime
6	4 Supreme
7	3 Distant
8	4 Prime
9	5 Supreme
10	4 Distant
11	5 Prime
12	6 Supreme
13	4 Final
14	5 Distant
15	6 Prime
16	7 Supreme
17	5 Final
18	6 Distant
19	7 Prime

By relabeling the 19 octaves of the Universe to indicate their relationship to one of the four families and by placing them in the chronological order of their occurrence, we have uncovered something quite astonishing...**the order in which an atom's energy shells fill with electrons!** In science, an atom's electron cloud has seven energy levels. The *first* energy level has 1 energy shell, the "s" shell. The *second* energy level has 2 energy shells, an "s" shell and a "p" shell. The *third* energy level has 3 shells: "s", "p", and "d". The *fourth* level has 4 shells: "s", "p", "d", and "f". (The *fifth* energy level would have-5, the *sixth*-6, and the *seventh*-7, but the existence of these higher energy shells is only presumed; i.e., we find no elements to confirm them). Fortunately, by using the known energy shells, we can compare the order in which they are filled with the order in which the 19 octaves occur.

The Order of the Filling of an Atom's <u>Energy Shells</u>	The FAMILY Order in which the 19 <u>Octaves Occur</u>
--	---

1s	1 Supreme = 1s
2s	2 Supreme = 2s
2p	2 Prime = 2p
3s	3 Supreme = 3s
3p	3 Prime = 3p
4s	4 Supreme = 4s
3d	3 Distant = 3d
4p	4 Prime = 4p
5s	5 Supreme = 5s
4d	4 Distant = 4d
5p	5 Prime = 5p
6s	6 Supreme = 6s
4f	4 Final = 4f
5d	5 Distant = 5d
6p	6 Prime = 6p
7s	7 Supreme = 7s
5f	5 Final = 5f
6d	6 Distant = 6d
7p	7 Prime = 7p

Naturally, we named the four families **Supreme**, **Prime**, **Distant**, and **Final** to correspond with the “current scientific designations” of these four energy shells; that is, **s**, **p**, **d**, and **f**.

## CONNECTIONS

Before we can complete the Periodic Table of Elements we must look back to what we previously discussed in chapter four concerning the duality of an octave--how two “entities” live in an octave with *one entity's* **down force** occupying the same place as *the other entity's* **up force**.

*This concept appears in the world of electrons. Quantum Physics allows two electrons to share the same orbital. One of these electrons is said to have spin-down, and the other electron is said to have spin-up. This duality, when applied to the 19 octaves, appears to give us only 38 elements (19 x 2). It is only when we examine the formation of the 19 octaves and how the different families "connect" to the original octave that the idiosyncrasies come into view.*

The original octave--the 1s octave--consists entirely of Supreme Vibrations. All Supreme Octaves are in direct contact with Supreme Vibrations. They have only their own duality (s shells have one orbital with two electrons).

The Prime Octaves do not connect directly to the original octave, the octave of the Absolute. Prime Octaves cannot exist unless they produce a connection to the original octave. With simple observation we can see that Prime Vibrations connect to the original octave through the second Supreme Octave, or in other words, the first two Supreme Octaves must exist for the Prime Octaves to exist. Prime Octaves must, therefore, have two dualities in themselves to represent these two Supreme Octaves. Prime Octaves also have a third duality--the duality of their own octave. All Prime Octaves have three dualities that allow for six entities to exist (p shells have three orbitals with two electrons in each orbital--six electrons).

The third family--the Distant Octaves--also must make a connection to the original octave. Distant Vibrations connect to the second Prime Octave (3p). The second Prime Octave (3p) connects to the first Prime Octave (2p). The first Prime Octave (2p) connects to the second Supreme Octave (2s), and the second Supreme Octave (2s) connects to the first Supreme Octave (1s)--the original octave. For Distant Octaves to exist, there must be two Supreme Octaves and two Prime Octaves. Distant Octaves must, therefore, have four dualities in themselves to represent these four octaves. Distant Octaves also have a fifth duality--their own duality. Distant Octaves have a total of five dualities--ten points of existence (d shells have five orbitals with two electrons in each orbital--ten electrons).

Lastly, the Final Vibrations connect to the Supreme Vibrations through two Distant Octaves, two Prime Octaves, and two Supreme Octaves. Therefore, all Final Octaves must have six dualities to represent these six connections and also a seventh duality--their own duality. Final Octaves have a total of seven dualities, or fourteen points of existence (f shells have seven orbitals with two electrons in each orbital--fourteen electrons).



## THE PERIODIC TABLE OF THE ELEMENTS

Having traced the connections for each family back to the original octave we are now ready to create the Periodic Table of Elements. To do this, we must take into account the following idea: the Universe begins with seven Supreme Vibrations; in a manner of speaking, we could say these seven Supreme Vibrations “**START**” the Universe. Every Supreme Octave contains Supreme Vibrations; therefore, every Supreme Octave represents a start position within the Universe. We will call these start octaves [new beginning octaves]. Postulation: *If Supreme Octaves represent start positions within the Universe, then all octaves immediately preceding Supreme Octaves must, therefore, represent “STOP” positions* (pages 111, 116, and 117).

*Start positions imply something is about to begin.*

*Stop positions imply something is about to end.*

Although there is great significance to that which begins, there is, perhaps, an even greater significance to that which ends! Let me explain. All octaves have a duality; that is, after producing dualities to represent their connections to the Supreme Vibrations, all octaves *end* with their own duality. *This duality is an ending.* Supreme Octaves do not have to establish any connections; they end by simply completing their own duality. However, before Prime Octaves can end with their own duality they must first produce two dualities to represent their connections to the 2s and 1s octaves. Distant Octaves must produce four dualities for their connections, then likewise, end by completing their own duality, and so forth. *Each octave’s duality is an ending, and every ending represents a fullness.*

Note: All octaves that immediately precede Supreme Octaves are *stop octaves*. At the moment stop octaves complete the fullness of their own duality they achieve *an even greater state of fullness*. This greater fullness occurs throughout the structure of the 19 octaves. For identification purposes, we will call the fullness at the end of any octave’s completing duality, a “**personal ending duality**”; and the greater fullness occurring at the end of a stop octave’s completing duality, a “**big ending duality**”. Thus, we have two kinds of endings possible: one ending occurs at the *completion of an octave’s own personal duality*; the other ending occurs at the *completion of a stop octave’s duality*, where its personal ending duality also stands in the dynamic position of being a big ending duality [a greater fullness within the structure].

BIG END		NB/PE	

In order to represent these two endings, we need two main columns. Each main column will be sub-divided into two inner columns; that is, its duality. In addition, since stop octaves always precede start octaves, the first main column will be for stop octaves [big ending dualities]. We shall label this column “**BIG END**”.

The second main column will be for start octaves [new beginning octaves], as well as all other octaves, which, like new beginning octaves, have a personal ending duality...not a big ending duality. We shall label this column “**NB/PE**” to represent these [new beginning and/or personal ending dualities]. We are now ready to begin filling the columns, element by element (to follow along please refer to page 119). Tip: Circle the stop octaves (octaves that **precede** the Supreme Octaves) on page 119 (1s, 2p, 3p, 4p, 5p, 6p, and 7p).

BIG END		NB/PE	
		<b>1</b>	
<b>2</b>			
		<b>3</b>	
			<b>4</b>

The first two elements appear in the 1s octave’s duality. Immediately, we seem to have a dilemma...the 1s octave is a start octave (its elements should go in the NB/PE columns). However, following the 1s octave is the 2s octave--also, a start octave. This makes the 1s octave a **stop octave**; and its completing duality a **big ending duality** (its elements should go in the BIG END columns). Note: Later, when we address what Mr. Gurdjieff called the “inner Ansapalnian-octave”, this dual possibility for the 1s octave will become apparent. For now,

we can reconcile this dilemma and satisfy both columns by splitting the duality of the 1s octave. **The first element** in the 1s octave is the first element in the Universe; it therefore goes in the *first* NB/PE column. **The second element**--the completing duality of the 1s octave--also stands in the dynamic position of being a big ending and, therefore, goes in the *second* BIG END column.

Following the 1s octave is the 2s octave. In the 2s octave, the 3rd and 4th elements enter. For them, only one choice is possible. They are created in a start octave, a new beginning octave; therefore, the 3rd and 4th elements go in the NB/PE columns. This completes the first two Supreme Octaves.

			BIG END		NB/PE	
	5				1	
9				2		
	7				3	
		8				4
			9			
				10		

The first Prime Octave, the 2p [a stop octave] is next, and as explained earlier (page 119), Prime Octaves must have an inner representation of their connection back to the original octave; one duality to represent the original Supreme Octave, 1s, and one duality to represent the second Supreme Octave, 2s. Elements 5 and 6 satisfy the first duality, and elements 7 and 8 the second. *To represent these four connections back to the 1s octave, we simply insert*

*corresponding rows in the diagram.* Now, by copying the same structure that was formed in positioning elements 1, 2, 3, and 4 in the columns, we will insert elements 5, 6, 7, and 8 in the corresponding rows. Finally, elements 9 and 10, the 2p octave's own personal duality, also stands as a big ending duality. The dynamic position of being a big ending requires that elements 9 and 10 go in the BIG END columns.

After this, we have two elements in the 3s octave--a new beginning octave. This octave creates elements 11 and 12; they have only one choice, the NB/PE columns.

At this point, we come again to a stop octave, the 3p. It creates elements 13, 14, 15, 16, 17, and 18. Elements 13, 14, 15, and 16 go into the rows that correspond to elements 1, 2, 3, and 4. Elements 17 and 18 go into the BIG END column below elements 9 and 10.

				BIG END		NB/PE	
	13	5				1	
14		6			2		
	15	7				3	
		16	8				4
				9			
					10		
				17		11	
					18		12

										BIG END	NB/PE	
					5							1
	31		21		13		6					2
	32		22		14		7					3
		33		23		15		8				4
			34		24		16		9			
					25		17		10			
					26		18		11			
					27		19		12			
					28		20		13			
									14			
									15			
									16			
									17			
									18			
									19			
									20			
									21			
									22			
									23			
									24			
									25			
									26			
									27			
									28			
									29			
									30			
									31			
									32			
									33			
									34			
									35			
									36			
									37			
									38			

Next, is the 4s octave, a new beginning octave. It gets two elements (19 and 20) in the NB/PE columns.

Following the 4s octave is the 3d octave. The 3d octave has to satisfy dualities for the 1s, 2s, 2p, and 3p octaves (page 119). Elements 21 through 28 go in the rows that correspond to the dualities of elements (1 & 2), (3 & 4), (9 & 10), and (17 & 18). The last two elements represent the 3d's personal duality, i.e., elements 29 and 30 go in the NB/PE columns.

The 4p octave [a stop octave] acts exactly as all previous Prime Octaves, creating elements 31, 32, 33, and 34 in the corresponding rows; followed by elements 35 and 36 which go in the BIG END columns

At this point, the 5s octave--a new beginning octave--creates elements 37 and 38 in the NB/PE columns.

Octaves 4d, 5p, and 6s follow the same configurations as the 3d, 4p, and 5s octaves: **the 4d octave creates** elements 39 to 48 (elements 39, 40, 41, 42, 43, 44, 45, and 46 in the requisite rows and 47 and 48 go in the NB/PE columns); next, **the 5p octave creates** elements 49 to 54 (elements 49, 50, 51, and 52 go in corresponding rows and 53 and 54 go in the BIG END columns); then, **the 6s octave creates** elements 55 and 56 in the NB/PE columns.

										BIG END	NB/PE	
												1
												2
												3
												4
												5
												6
												7
												8
												9
												10
												11
												12
												13
												14
												15
												16
												17
												18
												19
												20
												21
												22
												23
												24
												25
												26
												27
												28
												29
												30
												31
												32
												33
												34
												35
												36
												37
												38
												39
												40
												41
												42
												43
												44
												45
												46
												47
												48
												49
												50
												51
												52
												53
												54
												55
												56

		BIG END	NB/PE	
			1	
			2	
			3	
			4	
			5	
			6	
			7	
			8	
			9	
			10	
			11	
			12	
			13	
			14	
			15	
			16	
			17	
			18	
			19	
			20	
			21	
			22	
			23	
			24	
			25	
			26	
			27	
			28	
			29	
			30	
			31	
			32	
			33	
			34	
			35	
			36	
			37	
			38	
			39	
			40	
			41	
			42	
			43	
			44	
			45	
			46	
			47	
			48	
			49	
			50	
			51	
			52	
			53	
			54	
			55	
			56	
			57	
			58	
			59	
			60	
			61	
			62	
			63	
			64	
			65	
			66	
			67	
			68	
			69	
			70	

We are now at the 4f octave. The 4f octave has seven dualities. Twelve elements (57, 58, 59, 60, 61, 62, 63, 64, 65, 66, 67, and 68) form in the rows corresponding to the six dualities of elements (1 & 2), (3 & 4), (9 & 10), (17 & 18), (29 & 30), and (47 & 48) (page 119). The seventh duality is the 4f octave's personal duality. Elements 69 and 70 go in the NB/PE columns.

This completes the configuration as to the placement of elements for each "family of octaves".

The last six octaves obey the same configuration as all prior family octaves, creating the final 47 elements. That does it! Now, let us label the diagram in greater detail.

The BIG END column had two inner columns, one column for each aspect of an octave's completing duality. We will momentarily label these inner columns X and Y.

	X	Y	
			1
			2
			3
			4
			5
			6
			7
			8
			9
			10
			11
			12
			13
			14
			15
			16
			17
			18
			19
			20
			21
			22
			23
			24
			25
			26
			27
			28
			29
			30
			31
			32
			33
			34
			35
			36
			37
			38
			39
			40
			41
			42
			43
			44
			45
			46
			47
			48
			49
			50
			51
			52
			53
			54
			55
			56
			57
			58
			59
			60
			61
			62
			63
			64
			65
			66
			67
			68
			69
			70
			71
			72
			73
			74
			75
			76
			77
			78
			79
			80
			81
			82
			83
			84
			85
			86
			87
			88
			89
			90
			91
			92
			93
			94
			95
			96
			97
			98
			99
			100
			101
			102
			103
			104
			105
			106
			107
			108
			109
			110
			111
			112
			113
			114

The Y column contains the last elements before a new beginning. Nothing more is possible. It represents a state of fullness, a totality. Therefore, we shall label the Y column, column 0, because 0 best represents this fullness. The X column contains the next to last elements before a new beginning. In the Law of Octaves the seventh vibration in an octave is the next to last vibration; therefore,

we shall relabel our X column, column VII. We will use Roman Numerals to distinguish the column numbers from the element numbers.

	VII	0	I	II
			1	
		2		
			3	
				4
			5	
				6
			7	
				8
			9	
				10
			11	
				12
			13	
				14
			15	
				16
			17	
				18
			19	
				20
			21	
				22
			23	
				24
			25	
				26
			27	
				28
			29	
				30
			31	
				32
			33	
				34
			35	
				36
			37	
				38
			39	
				40
			41	
				42
			43	
				44
			45	
				46
			47	
				48
			49	
				50
			51	
				52
			53	
				54
			55	
				56
			57	
				58
			59	
				60
			61	
				62
			63	
				64
			65	
				66
			67	
				68
			69	
				70
			71	
				72
			73	
				74
			75	
				76
			77	
				78
			79	
				80
			81	
				82
			83	
				84
			85	
				86
			87	
				88
			89	
				90
			91	
				92
			93	
				94
			95	
				96
			97	
				98
			99	
				100
			101	
				102
			103	
				104
			105	
				106
			107	
				108
			109	
				110
			111	
				112
			113	
				114
			115	
				116
			117	
				118
			119	
				120
			121	
				122
			123	
				124
			125	
				126
			127	
				128
			129	
				130
			131	
				132
			133	
				134
			135	
				136
			137	
				138
			139	
				140
			141	
				142
			143	
				144
			145	
				146
			147	
				148
			149	
				150
			151	
				152
			153	
				154
			155	
				156
			157	
				158
			159	
				160
			161	
				162
			163	
				164
			165	
				166
			167	
				168
			169	
				170
			171	
				172
			173	
				174
			175	
				176
			177	
				178
			179	
				180
			181	
				182
			183	
				184
			185	
				186
			187	
				188
			189	
				190
			191	
				192
			193	
				194
			195	
				196
			197	
				198
			199	
				200
			201	
				202
			203	
				204
			205	
				206
			207	
				208
			209	
				210
			211	
				212
			213	
				214
			215	
				216
			217	
				218
			219	
				220
			221	
				222
			223	
				224
			225	
				226
			227	
				228
			229	
				230
			231	
				232
			233	
				234
			235	
				236
			237	
				238
			239	
				240
			241	
				242
			243	
				244
			245	
				246
			247	
				248
			249	
				250
			251	
				252
			253	
				254
			255	
				256
			257	
				258
			259	
				260
			261	
				262
			263	
				264
			265	
				266
			267	
				268
			269	
				270
			271	
				272
			273	
				274
			275	
				276
			277	
				278
			279	
				280
			281	
				282
			283	
				284
			285	
				286
			287	
				288
			289	
				290
			291	
				292
			293	
				294
			295	
				296
			297	
				298
			299	
				300

The NB/PE column was also divided into two inner columns. These inner columns contained two elements, which represented the octave's own personal duality. Therefore, we will label these two inner columns, columns I and II.

This completes the labeling of the columns. Now before we can label the rows, we must simplify the diagram.

First we need to eliminate the unoccupied rows. We can accomplish this by either combining them with an adjacent, occupied row, or if there is not one, by deleting them all together.

Labeling the rows requires that we take into consideration the labels used in labeling the columns.

	VII	0	I	II
		1		
		2		
		3		
		4		
		5		
		6		
		7		
		8		
		9		
		10		
		11		
		12		
		13		
		14		
		15		
		16		
		17		
		18		
		19		
		20		
		21		
		22		
		23		
		24		
		25		
		26		
		27		
		28		
		29		
		30		
		31		
		32		
		33		
		34		
		35		
		36		
		37		
		38		
		39		
		40		
		41		
		42		
		43		
		44		
		45		
		46		
		47		
		48		
		49		
		50		
		51		
		52		
		53		
		54		
		55		
		56		
		57		
		58		
		59		
		60		
		61		
		62		
		63		
		64		
		65		
		66		
		67		
		68		
		69		
		70		
		71		
		72		
		73		
		74		
		75		
		76		
		77		
		78		
		79		
		80		
		81		
		82		
		83		
		84		
		85		
		86		
		87		
		88		
		89		
		90		
		91		
		92		
		93		
		94		
		95		
		96		
		97		
		98		
		99		
		100		
		101		
		102		
		103		
		104		
		105		
		106		
		107		
		108		
		109		
		110		
		111		
		112		
		113		
		114		

In the columns we have used the labels VII, 0, I, and II. These columns represent each octaves' personal duality. Columns I and II represent both new beginning dualities and personal ending dualities; while columns VII and 0 represent big ending dualities, that is, all personal ending dualities that also stand in the dynamic position of being stop octaves. Having already used the labels VII, 0, I, and II to indicate these aspects of an octave's personal duality, prompts us to label the rows--III--IV--V--VI, but what do we use after VI? We have already used the label VII, after which things stopped (label 0)! The answer comes from



of what we are now going to do, which is re-establish the original columns. Note: There are three shaded squares in the diagram. They are pivot points. Rows I and II, both pivot around the shaded square above row II. Rows VII and 0, pivot around the shaded squares found in their row.

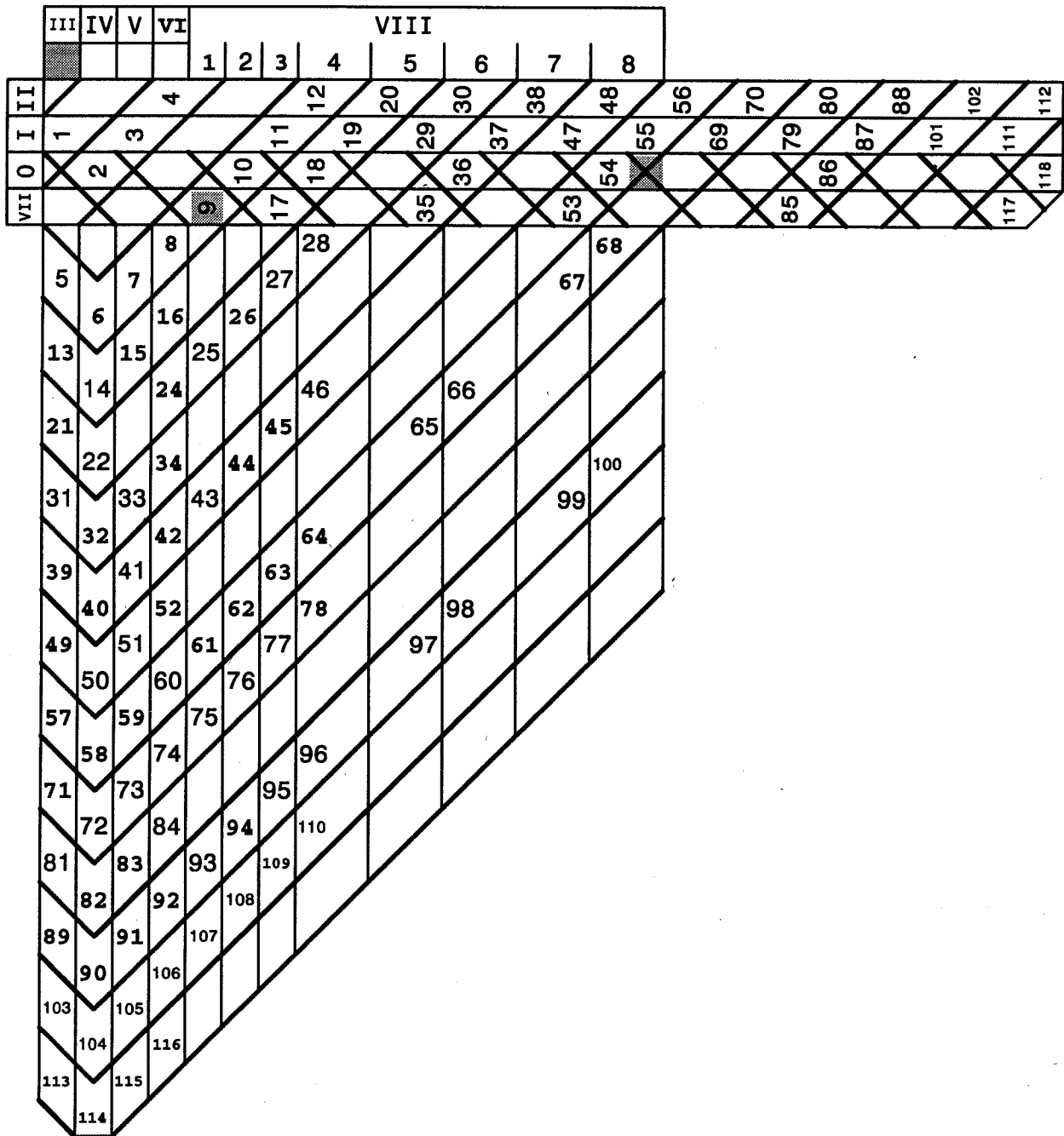

**That does it! We can now complete the re-establishment of the original columns, by simply performing the pivots...and watching the results.**

# EUREKA!

We now have a structure of vertical columns and V-shaped rows precisely matching the Periodic Table of Elements; or rather, we should say, "creating the Periodic Table of Elements".

The "crisscross" lines that we previously inserted in rows VII and 0 are now congruous, and the new short lines, which are not, indicate the stop properties of column 0, as well as identify column VII as Mr. Gurdjieff's "inner Ansapalnian-octave".

If you recall, we observed how hydrogen qualified for more than column I; i.e., hydrogen also qualified for column VII. Now, if we insert hydrogen in column VII, i.e., "its additional place of qualification", it will then become a part of Mr. Gurdjieff's "inner Ansapalnian-octave".

Note: Column VII is now positioned on top of column VIII-1.

								0						
								2						
								10						
								18						
								36						
I	II	III	IV	V	VI	VII	VIII							
1						1	2	3	4	5	6	7	8	
3														54
	4													
						8			28					68
11		5				17		27					67	
	12		6			16		26						
19		13				25								86
	20		14			24		46			66			
29		21				35		45		65				
	30		22			34		44					100	
37		31				43							99	
	38		32			42		64						
47		39				53		63						118
	48		40			52		78			98			
55		49				61		77			97			
	56		50			60		76						
69		57				75								
	70		58			74		96						
79		71				85		95						
	80		72			84		94		110				
87		81				93		109						
	88		82			92		108						
101		89				107								
	102		90			106								
111		103				117								
	112		104			116								
		113				115								
			114											

## INNER ANSAPALNIAN OCTAVE

“By the way, you should know that this same Hydrogen of theirs is just one of those seven cosmic substances which in their general totality actualize specially for the given solar system what is called the ‘inner Ansapalnian-octave’ of cosmic substances, which independent octave, in its turn, is a one-seventh independent part of the fundamental ‘common-cosmic Ansapalnian-octave.’

“Such an inner independent Ansapalnian-octave is likewise present in that solar system to which our dear Karatas belongs, and we call these seven heterogeneous cosmic substances of different properties:

- (1) Planekurab--which is just their Hydrogen
- (2) Alillonofarab
- (3) Krilnomolnifarab
- (4) Talkoprafarab
- (5) Khritofalmonofarab
- (6) Sirioonorifarab
- (7) Klananoizufarab

“And on your planet the genuine learned beings at different periods called by various names these same seven relatively independent crystallizations of different properties or according to their expression active elements, which compose the inner Ansapalnian-octave of their own solar system; the contemporary, as they are called, learned chemists there, however, who are already ‘learned-of-new-formation-of-the-first-water’ call them:

- (1) Hydrogen
- (2) Fluorine
- (3) Chlorine
- (4) Bromine
- (5) Iodine

“For the last two definite crystallizations they have no names at all because their names did not reach them from their ancestors, and at the present time they even do not suspect the existence on their planet of these two cosmic substances, although these two cosmic substances are the principal necessary factors for their own existence.”<sup>20</sup>

Gurdjieff completed his writings in the early 1940's...in 1947 scientists discovered Astatine, the sixth element in the "inner Ansapalnian-octave".

Perhaps someday scientists will discover the 117th element; the *seventh and final diatomic halogen* that completes Mr. Gurdjieff's "inner Ansapalnian-octave". Note: According to the incomplete structure of the 19th octave, the 117th element [the final element in the "inner Ansapalnian-octave"] will, correspondingly, be *the final element* in the Periodic Table of Elements and in the physical universe!

**WE REFER TO IT AS "GURDJINE", A NAME WE FIND MOST APPROPRIATE.**

We have a working model of the Periodic Table of Elements mounted on the wall where we gather, and a three dimensional model of the 19 octaves hanging from the ceiling. We often refer to them, and always seem to draw greater insight into *The Universal Cosmic Weave*.



**TI**

## CHAPTER SEVEN

# TRAVERSING SUSPENDED CONTINUITY

We began this exposition into the laws of World-creation and World-maintenance by studying the *simplicity* of the musical octave--Do, Re, Mi, Fa, So, La, Ti, Do. Then, dogs--axioms--began to appear...diatonic ratios...pure recurring decimals...the changing of the laws...the mathematical inner structure of the octave *unfolded before our eyes*...oscillations emerged...the structure of protons, neutrons, and quarks came into view...RNA and DNA were in mathematical clarity...the first chord sounded in the Universe and outer octaves were born...Pascal's triangle...the Fibonacci series...the Periodic Table of Elements...Whew! We have been on quite a journey; that is, from the *simplicity* of the musical octave--to here! Hopefully we can finish as worthily. Perhaps, even worthy of this Gurdjieff proclamation: "The 'obligatory-gap-aspects-of-the-unbroken-flowing-of-the-whole' are traversed!"

Having introduced Gurdjieff's objective definition (*All and Everything*, page 832) concerning the two famous intervals that were referred to in chapter one, we will now resolve the question as to why these two "obligatory-gap-aspects" exist. To begin, pick an octave...any octave! For example, the 6p octave; the dog becomes evident if we compute and examine the *outer octaves* that share a common vibration with it. This will require us to calculate octaves beyond the nineteenth outer octave. By identifying the octaves that share a common vibration with the 6p octave, we will be able to detect the effects they have on it.

### OCTAVES THAT SHARE VIBRATIONS WITH THE 6p OCTAVE

2s	2p	3p	4s	4p	5p	6s	<b>6p</b>	7p	8s	8p	9p	10s	10p	11p	12s	12p
				FA		LA	DO		MI	SO		TI	RE			
	LA	DO		MI	SO		TI	RE								
					FA		LA	DO		MI	SO		TI	RE		
	FA		LA	DO		MI	SO		TI	RE						
							FA		LA	DO		MI	SO		TI	RE
		FA		LA	DO		MI	SO		TI	RE					
LA	DO		MI	SO		TI	RE									
				FA		LA	DO		MI	SO		TI	RE			

The chart on the previous page identifies all outer octaves that have one or more of the same vibrations as the 6p octave. If we consider the knowledge we discussed in chapter four, regarding *the major oscillation* in an octave, it becomes clear, since both the 2p and 4p octaves have their major oscillations [LA-FA] ending on vibrations that *coincide with vibrations* in the 6p octave, that the 6p octave will feel these two oscillations.

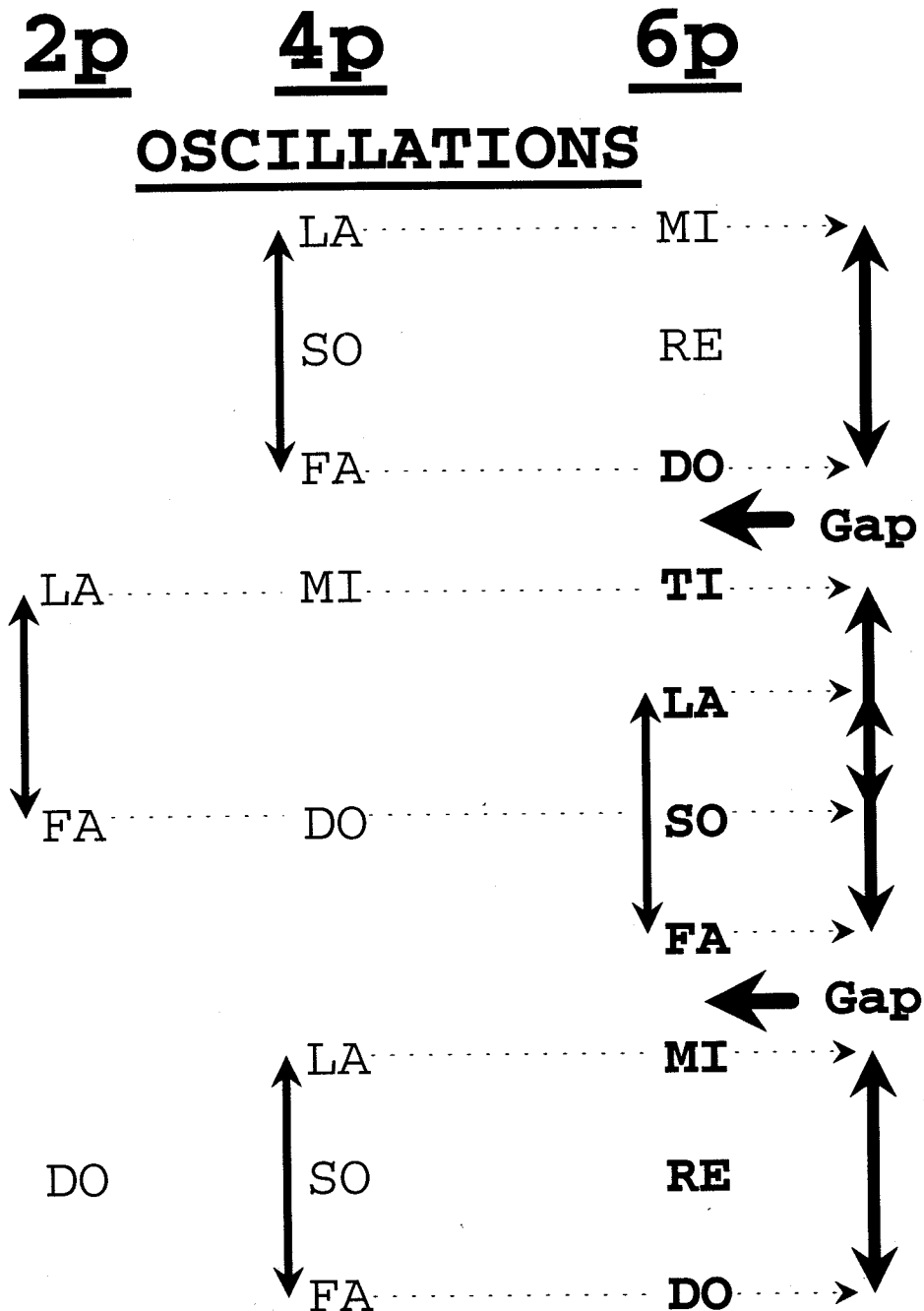

Studying the 2p, 4p, and 6p octaves, and the oscillation that each contributes, clearly shows that the 6p octave will experience *three* oscillations. The 6p octave has its own major oscillation, LA-FA. The 6p octave also senses a major oscillation between TI and SO (TI and SO match vibrations with the 2p octave's major oscillation, LA-FA). Finally, the 6p octave perceives still another major oscillation between MI and DO (MI and DO match vibrations with the 4p octave's major oscillation, LA-FA). The only intervals in the 6p octave that are not spanned by a major oscillation are precisely the intervals: DO-TI and FA-MI.

**WE HAVE DISCOVERED WHY THE TWO FAMOUS INTERVALS EXIST BETWEEN DO-TI AND BETWEEN FA-MI. THEY EXIST AS INTERVALS BECAUSE THEY ARE GAPS BETWEEN MAJOR OSCILLATIONS! THEY ARE, AS GURDJIEFF DEFINED THEM: "OBLIGATORY-GAP-ASPECTS-OF-THE-UNBROKEN-FLOWING-OF-THE-WHOLE".**

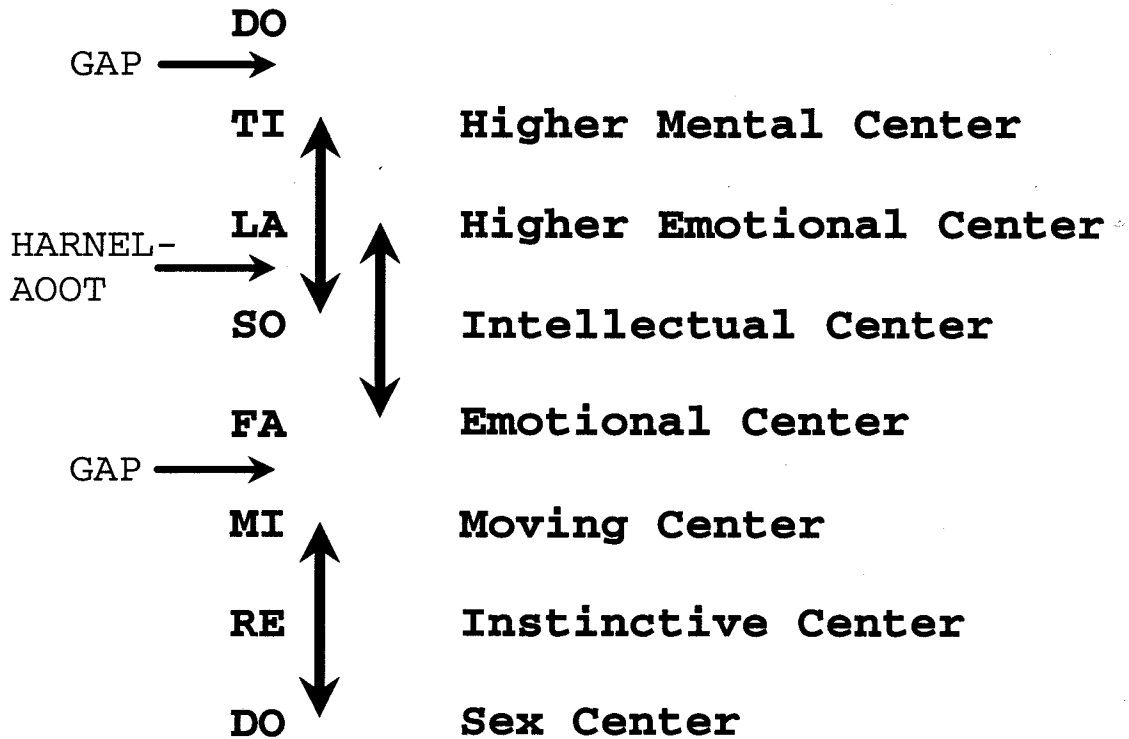

In conjunction with these three major oscillations, if we configure the seven centers in the form of an octave, we find: the MI-DO major oscillation connects the (*moving center* to the *sex center*), the LA-FA major oscillation connects the (*higher emotional center* to the *emotional center*), and the TI-SO major oscillation connects the (*higher mental center* to the *intellectual center*).

This structure further indicates why Man is depicted as a three-story factory: an octave is not only segmented into three inner octaves--top, middle, and bottom; it is also divided into three oscillations--lower, middle, and upper. *It is absolutely remarkable that both structures--the three scale-1 inner octaves, and the three major oscillations--reinforce the "three-fold aspect" of the Law of Three.* In addition, notice how, on page 137, the Harnel-Aoot (the 5th Stopinder--between SO and LA) is caught in two oscillations. This is indicative of the Harnel-Aoot being *disharmonized*, that is, the point of most tension.

## THE SEQUENCE

We shall now move on to other particulars in the "unbroken flowing of the whole" that still need exploring; one of which comes from chapter five where we promised to explain how every note in an octave becomes, simultaneously, a DO, TI, LA, SO, FA, MI, and RE in some other octave. **This truth reveals itself if we again refer to the chart showing the 6p octave and the other outer octaves that also contain one of the same vibrations as the 6p octave.**

2s	2p	3p	4s	4p	5p	6s	6p	7p	8s	8p	9p	10s	10p	11p	12s	12p
				FA	-----	LA	DO	-----	MI	SO	-----	TI	RE			
	LA	DO	-----	MI	SO	-----	TI	RE								
					FA	-----	LA	DO	-----	MI	SO	-----	TI	RE		
	FA	-----	LA	DO	-----	MI	SO	-----	TI	RE						
							FA	-----	LA	DO	-----	MI	SO	-----	TI	RE
		FA	-----	LA	DO	-----	MI	SO	-----	TI	RE					
LA	DO	-----	MI	SO	-----	TI	RE									
				FA	-----	LA	DO	-----	MI	SO	-----	TI	RE			

In the chart it is strikingly obvious that every vibration in the 6p octave falls in a series of notes that runs from left to right in the following sequence:

# FA-LA-DO-MI-SO-TI-RE

The only vibrations in the 6p octave not in this sequence, are the 6p's TI and RE. They are in the sequence:

## LA-DO-MI-SO-TI-RE

The sequence usually begins with a FA unless the LA of the sequence originates in either the first or second octave of any family: (1s, 2s) (2p, 3p) (3d, 4d) (4f, 5f). We shall leave it to the reader to study these sequences and will also challenge the reader to find yet another sequence, one only available to certain Supreme octaves. After such a thorough study, you will understand why outer octaves always have their vibrations fall in either the FA-LA-DO-MI-SO-TI-RE sequence, the LA-DO-MI-SO-TI-RE sequence, or the other sequence you have discovered. The sequences are like windows, where a vibration comes into being as a FA or LA in some outer octave, and then reappears in other outer octaves, following the sequence, until it finally becomes a RE. After which the window closes and the vibration ceases; that is, it is never used again by any other outer octave no matter how many octaves are computed.

*Remember, the outer octaves came into existence by “only” originating octaves [a diatonic DO to DO] at the forces--LA and FA; i.e., LA’s became DO’s and FA’s became DO’s. However, when we examine the 6p octave and the sequence, FA-LA-DO-MI-SO-TI-RE, existing at each vibration, we discover that...*

## **EVERY VIBRATION IN THE 6P OCTAVE IS THE DIATONIC DO OF ANOTHER OCTAVE:**

*TI in the 6p octave is the diatonic DO of the 3p octave.*

*LA in the 6p octave creates the diatonic DO of the 7p octave.*

*SO in the 6p octave is the diatonic DO of the 4p octave.*

*FA in the 6p octave creates the diatonic DO of the 8p octave.*

*MI in the 6p octave is the diatonic DO of the 5p octave.*

*Finally, RE in the 6p octave is the diatonic DO of the 2p octave.*

Again, I repeat, “**we did not create an octave (DO to DO) at every note**”; we began by creating octaves ONLY at LA’s and FA’s, at the forces. However, the formation of outer octaves results in a structure that has “**a diatonic force**”, LA or FA, *at every note...which also creates “a diatonic octave” at every note!*

Continuing our study regarding how the outer octaves connect leads us to also examine where the outer octaves disconnect; that is, if we made a chart of just the Supreme octaves (see page 140), we would find that some of the vibrations in

the 1s octave are also vibrations in the 2s, 3s, 4s, 5s, 6s, and 7s octaves. However, none of the 1s octave's vibrations are vibrations in the 8s octave. Likewise, none of the 2s octave's vibrations are vibrations in the 9s octave, nor the 3s in the 10s, and so forth. It is apparent that after the seventh family member the connection is broken with the first family member.

The following diagram reveals all Supreme octaves that contain one of the same vibrations as the 7s octave:

### OCTAVES CONTAINING A 7s VIBRATION

```

1s 2s 3s 4s 5s 6s 7s
  2s 3s 4s 5s 6s 7s 8s
    3s 4s 5s 6s 7s 8s 9s
      4s 5s 6s 7s 8s 9s 10s
        5s 6s 7s 8s 9s 10s 11s
          6s 7s 8s 9s 10s 11s 12s
            7s 8s 9s 10s 11s 12s 13s
  
```

Notice that there are six family octaves created before the 7s octave and six family octaves created after it, for a total of thirteen octaves. In chapter three, regarding the process of defining an octave, we configured *thirteen related "inner" octaves in three scales*; ironically, there are also *thirteen related "family" octaves in the outer scale*. We encourage you to study the connections among outer octaves, for many other truths await you; but now, we must move onward to other frontiers.

In chapter three when we examined how the deck of cards portrayed the inner octaves--80 notes in 13 octaves across three scales--we found if a card was a Fa in one scale the card was a Fa in all scales. The only exceptions were the Jokers: the Extra Joker (a LA in scale-0, a LA in scale-1, and a La in scale-2) was the ascending DO in scale-0; the Joker (a TI in scale-0, a TI in scale-1, and a Ti in scale-2) was the descending DO in scale-0. We envisioned these two DO's as two notes from an unknown previous scale.

By defining the unknown previous scale, we will be able to reconcile these exceptions. To do this, we must consider that *the deck of cards was designed specifically to represent the 80 notes in the three scales of the Octave of Man*; then--study as an octave--the evolutionary ascension of Life and the formation of Man's seven centers [brains].

The *Spiritual world's range of existence* is defined by two octaves--an ascending and a descending octave (see chapter four). The *Physical world's range of existence* is also defined by two octaves--an ascending and a descending octave. There is a **Spiritual octave above life**; a **Physical octave below life**; and *in between--* where the descending *Spiritual octave* and the ascending *Physical octave* coincide--there is **LIFE!** The diagram examines how the *Spiritual octave* filters down this Octave of Life and law conformably sets in motion the returning evolutionary ascent of multi-brained organisms "...the higher blends with the lower in order to actualize the middle..."; Spiritual + Physical = Life.

S  
P  
I  
R  
I  
T  
U  
A  
L

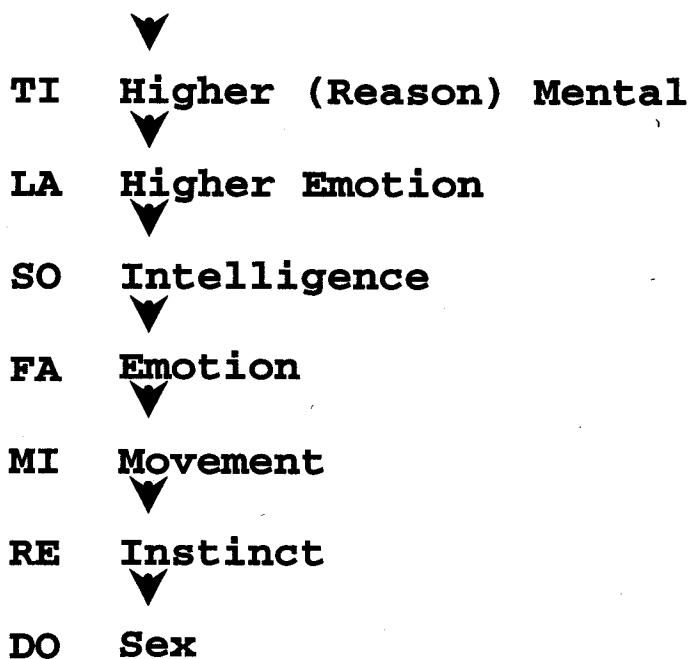

P  
H  
Y  
S  
I  
C  
A  
L



The **first brain**, as discussed in chapter three, represents the duplicating principle. Gurdjieff indicated that the **sex principle** originates *outside* the Universe, i.e., in the Holy Sun Absolute, and manifests the beginning and ending "**DO's**" of the Universe before the **second brain**, the **instinctive brain**, at "**DO**"-"**RE**", comes into being. Next, the **third brain**, the **moving brain**, comes into being, "**RE**"-"**MI**". This completes the Trinity of Brains in the **lower story**, the lower oscillation. The **fourth brain** is the **emotional brain**. It enters at the point where animals begin to recognize their offspring and, indeed, nurture them until they, so to say, leave the nest. The

**fifth brain** is the **intellectual brain**. We must break away from the popular concept that only Man is intellectual. This becomes apparent if we consider the intelligence of many animal species: bees that construct hexagonal combs, birds that return to the same nest year after year, dogs, cats, pigs, horses, chimpanzees, and so on, whose intelligence is beyond denial. The **sixth brain** is the **higher emotional brain**, "SO"-**"LA"**. Here, animals' social manifestations enter, also such phenomena as: the loyalty of dogs to their owners; or the willingness of many animal species to offer themselves as targets for predators in order to protect their young, or even to protect their colony, pack, or herd. These, and many others, are *higher* manifestations from which Man can learn a great deal...and sometimes even envies. Finally, the **seventh brain**, the **higher mental brain**, enters at **"LA"**-**"TP"**. It is *this brain that sets Man apart from all the other animals*. From this brain, **REASON** flows. It is not "intelligence" that makes Man the pinnacle of Creation, but rather, it is **R-E-A-S-O-N** that makes the difference.

Man's existence traverses the Stopinder **"LA"**-**"TP"**. It is in this octave, the octave of the higher mental center, between **"LA"** and **"TP"**, where Man comes into being; and it is this octave--the octave of the higher mental center--that is the unknown octave we previously discussed in chapter three.

The deck of cards, which represents the thirteen inner octaves of Man, fits within this Octave of Brains, and it fits between **"LA"** and **"TP"**; making the top **DO** in the Octave of Man a **"TP"**, and the bottom **DO** a **"LA"**.

<b>JOKER</b>	<b>"TP"</b>	<b>Higher Mental</b>	<b>DO</b>
		JOKER	TI
		EXTRA JOKER	LA
		ACE ♠	SO
		ACE ♥	FA
		ACE ♣	MI
		ACE ♦	RE
<b>EXTRA JOKER "LA"</b>		<b>Higher Emotional</b>	<b>DO</b>

Now you can see what appeared to be an exception, is not. The Extra Joker is "always" a La; it was even a La in the previous scale. The Joker is "always" a Ti, again, even in the previous scale. You may wish to return to chapter three and examine the octave of the cards. Study it with this idea in mind. Then, observe the three oscillations; how the oscillations connect the cards; and which cards they connect.

▼  
**TI Higher (Reason) Mental**  
 ▼  
**LA Higher Emotion**  
 ▼  
**SO Intelligence**  
 ▼  
**FA Emotion**  
 ▼  
**MI Movement**  
 ▼  
**RE Instinct**  
 ▼  
**DO Sex**

Additionally, anyone who has made a serious study of Tarot will recognize that the 22 cards in the Major Arcana are representative of the 22 vibrations in scale-1. The 56 cards in the Minor Arcana have a two-fold representation: they specifically portray the 54 vibrations in scale-2; and incorporate the Ace, 2, 3, 4, 5, 6, 7, 8, 9, 10, Jack, Queen, King, Ace (*similar to yet different from aspect of Aces*) sequence, that we discussed in chapter three. The 78 cards in Tarot represent the 78 notes between the Absolutes in the three inner scales of an octave! *It should be obvious to the reader that "Tarot" was not intended for fortune telling but was simply another attempt, by the ancients, to preserve knowledge pertaining to the Law of Seven and the structure of Man's inner world.*

## SEVENFOLDEDNESS

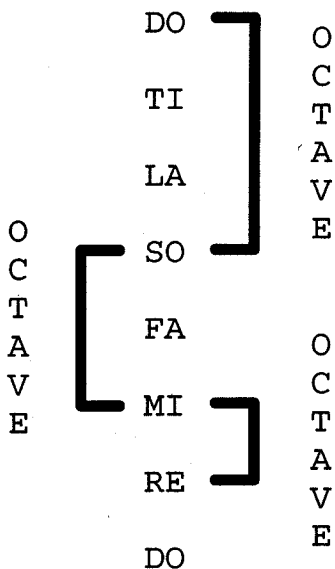

Gurdjieff's cosmology affirms, repeatedly, that within every Stopinder in an octave there comes forth another seven Stopinders; and within each of these seven Stopinders come seven more, and so forth. But how does this occur? The "dog" is revealed if we combine the inner octaves from chapter three with the outer octaves from chapter six. In chapter three we examined the three octaves of radiations between the four fundamental points--(DO to SO), (SO to MI), and (MI to RE). Notice that one of these three inner octaves, the inner octave from MI to RE, satisfies this idea, i.e., (seven Stopinders--in a Stopinder), or from one...comes seven...comes forty-nine...etc.

Also, when we examined the fate of the notes as they reappeared in scale-1 and scale-2, we found that **TI** became a **So** one scale removed from itself; this means that the notes **DO-TI** eventually becomes the notes **Do-So**, and since the notes **Do** and **So** are fundamental points they are connected by an octave. Therefore, the interval between the notes **DO** and **TI** (which becomes **Do-So**) is traversed by an octave.

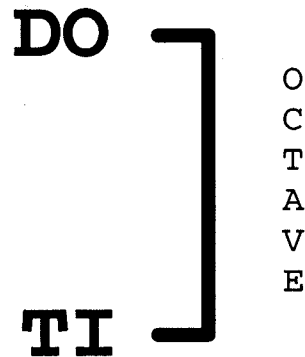

We now have an inner octave occurring within two Stopinders; the intervals Mi-Re and Do-Ti. At this point, if we return to the chart showing which outer octaves share vibrations with the 6p octave, we find that *the 8p octave* has its **MI-RE** inner octave and its **DO-TI** inner octave coinciding with the 6p octave's vibrations **LA-SO** and **FA-MI** respectively. It then becomes evident that these two inner octaves--in the 8p octave--are also felt as inner octaves in the 6p octave.

2s	2p	3p	4s	4p	5p	6s	6p	7p	8s	8p	9p	10s	10p	11p	12s	12p
				FA		LA	DO		MI	SO		TI	RE			
	LA	DO		MI	SO		TI	RE								
					FA		LA	DO		MI	SO		TI	RE		
	FA		LA	DO		MI	SO		TI	RE						
							FA		LA	DO		MI	SO		TI	RE
		FA		LA	DO		MI	SO		TI	RE					
LA	DO		MI	SO		TI	RE									
				FA		LA	DO		MI	SO		TI	RE			

We now have four Stopinders, or intervals, configured as octaves: (MI-RE) (DO-TI), (LA-SO), and (FA-MI). We can comprehend how the three remaining intervals become octaves by understanding the dynamics of the TI-DO and DO-RE intervals. Note: In chapter one (page 8) we observed how the TI-DO interval (3), was followed by the DO-RE interval (6)--an interval twice as large; and how the octave of 24 was followed by the octave of 48--an octave twice as large. This means that the octave created between TI-DO is naturally followed by an octave "twice as large"; an octave, which is precisely the size of the DO-RE interval. In chapter two we could only speculate "where" TI was displaced when the Absolute shortened the last Stopinder. Now we can understand "why" the Absolute placed TI in this position. The Absolute foresaw that the octave created between TI-DO [the "intentionally-actualized-Mdnel-In"] would, when doubling, create an octave between DO-RE; or as Gurdjieff explained it "...facilitate the commencement of a

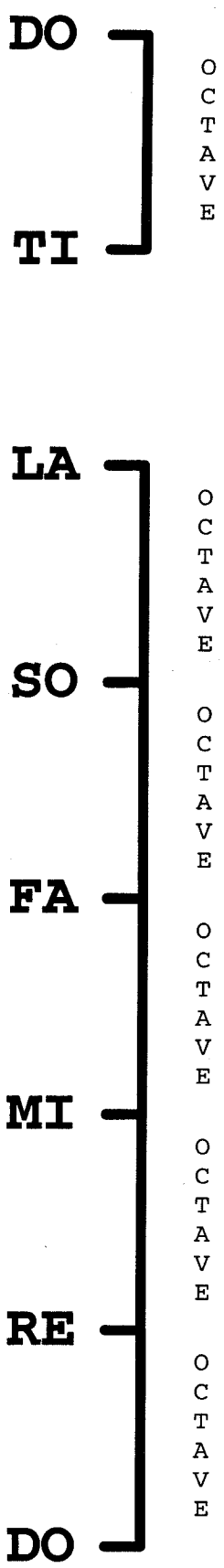

new cycle of its completing process...". In other words, by filling the Ti-Do interval with an octave, impetus is given to ascend...because with the possibility of doubling this octave comes the possibility of traversing the Do-Re interval and entering the greater octave above.

*This same phenomenon also applies to FA-SO, the "twice as large" interval above MI-FA. A TI-DO inner octave juxtaposed with the MI-FA interval doubles and bridges the FA-SO interval with an octave.*

The only interval in the octave left to span is the interval between LA-TI. To accomplish this we must return again to the chart of the 6p octave. Here we find that the FA-SO interval of the 5p octave coincides with the vibrations LA-TI in the 6p octave. And as just explained, the FA-SO interval becomes an octave by the doubling of a TI-DO interval juxtaposed with its MI-FA interval. When the FA-SO interval *becomes* an octave in the 5p octave so does the LA-TI interval in the 6p octave. We have now verified that an octave exists within every Stopinder of an octave; and therein, within every Stopinder of its inner octaves.

Pressing on, we find there are still more "dogs" to exhume. Now we shall tackle why Re is the bottom. Part of the answer comes from what we have just discussed; that is, the filling of any "intentionally-actualized-Mdnel-In" gives impetus for the next octave's ascension by traversing the interval between Do-Re. With this understanding--that Re is attained through a force that comes from the octave below--we can grasp the idea that what follows Re must belong to the octave above. Ti is the *top* for the octave below and Re is the *bottom* for the octave above. The filling of Ti-Do, the "intentionally-actualized-Mdnel-In", *by the act of doubling--* facilitates the commencement of a new cycle of the completing process--makes it to Re.

We discovered in chapter three when we examined the fate of the notes that Re not only became an ascending Do in the next inner scale, but was also the *absolute bottom* for that

scale. Furthermore, in Gurdjieff's cosmology we find that the Ray of Creation ends at the Moon; and the Moon--or the bottom of the Ray of Creation--is a Re.

Realizing that Re represents the bottom, or lowest state of an octave, the ground state, will prove helpful in tracing octaves back to their origin. Any octave whose RE is the same vibration as one of the vibrations of the 1s octave is a member of the Supreme family; any octave whose RE is the same vibration as one of the vibrations of the 2p octave is a member of the Prime family, etc.

We will now address the problem of "*why and where*" the fundamental outer cycle stops. We can find the dog by conceptualizing the three particularities of the fifth Stopinder in the sacred Law of Heptaparaparshinokh, the Harnel-Aoot.

*First Particularity:*

"If the completing process of this sacred law flows in conditions, where during its process there are many 'extraneously-caused-vibrations,' then all its functioning gives only external results."

*Second Particularity:*

"But if this same process proceeds in absolute quiet without any external 'extraneously-caused-vibrations' whatsoever, then all the results of the action of its functioning remain within that concentration in which it completes its process, and for the outside, these results only become evident on direct and immediate contact with it."

*Third Particularity:*

"And if however during its functioning there are neither of these two sharply opposite conditions, then the results of the action of its process usually divide themselves into the external and the internal."

In all three particularities, the word "its" refers to the "Harnel-Aoot". Three results ensue depending on the extent of "extraneously-caused-vibrations" present during the manifestation of this Stopinder. The "extraneously-caused-vibrations" are the forces that come into existence in the Universe; that is, all LA's and FA's that gave birth to new octaves are points of an "extraneously-caused-vibration". In order to understand *why* and *where* the fundamental outer cycle stops, we need to modify the diagram that identified the structural formation of the 19 octaves that actualized the Universe (page 103).

*Step-1:* First, we must single out the thirteen octaves that accomplish a Harnel-Aoot (LA-SO) in the Universe. Note: This only occurs to the first thirteen octaves. For identification, we will shade in these thirteen Harnel-Aoots.

*Step-2:* Draw a line through each force, LA and/or FA, that occurs **during** the first Harnel-Aoot. On the left of the diagram, number the line: 1, if it passes through only **one** force (LA or FA); 2, if it passes through **two** forces (LA and FA).

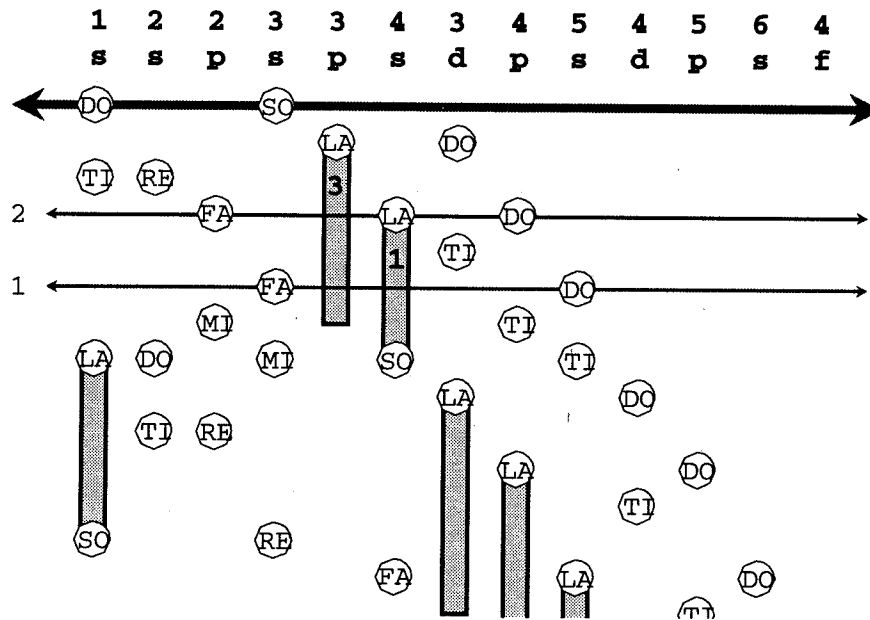

*Step-3:* As we proceed down the Universe, we **identify how many forces are present during the formation of each Harnel-Aoot**, and label its shaded area with a bold number to indicate the total forces that occur during its formation. Example: the 3p octave has two lines passing through it, representing 3 forces; thus, we will label the shaded area, **3**. As we complete each Harnel-Aoot, we must *apply one of the three particularities before we proceed*. We ask, are there (many forces-3 or 4), (no forces-0), (or in between-1 or 2)? If the *first particularity applies*, as it does in the first Harnel-Aoot, we will **terminate** the diatonic flow of the octave before reaching SO--**before completing the Harnel-Aoot**--interpreting the clue: “gives only external results”, as indicative of a personal termination. If the *second particularity applies*, we will **continue then cease** the diatonic flow of the octave, that is, **complete the Harnel-Aoot, then cease the octave at SO**--as indicated by the clue: “remain within that concentration in which it completes its process”. If the *third particularity applies*, we will **continue** the diatonic flow of the octave--**complete the Harnel-Aoot, then continue the octave past SO**--as indicated in the clue: “divide themselves into the external and internal”.

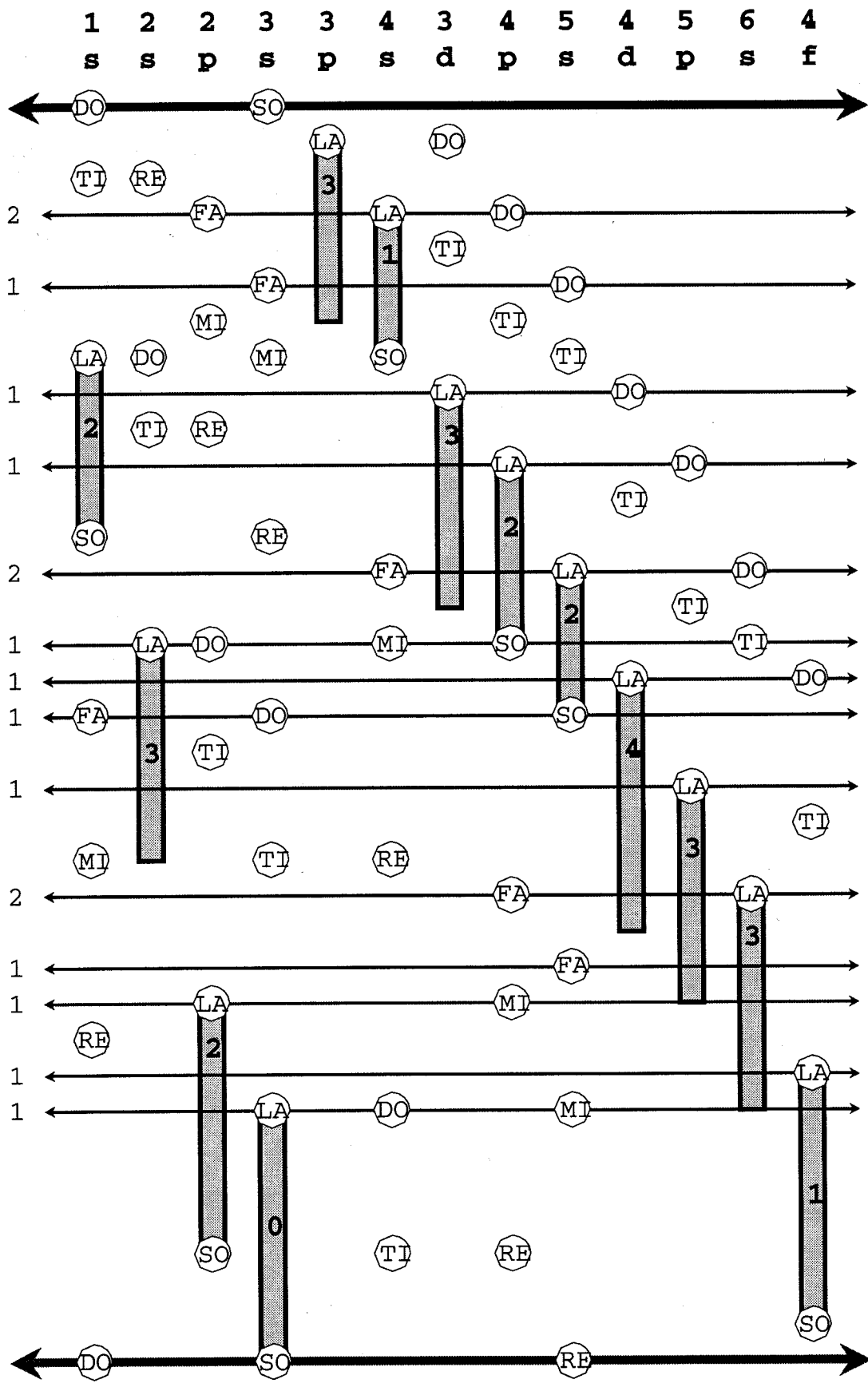

In the completed diagram, there are six Harnel-Aoots (3's & 4's) that give only external results; one Harnel-Aoot (0) that ceases upon completing itself; and six Harnel-Aoots (1's & 2's) giving both external results, as well as providing for their own self-continuation. Note: The Harnel-Aoot (0) that ceases upon completing itself, is exactly where the fundamental outer cycle stops, or rather, we should say, **“is the reason *why* the fundamental outer cycle ceased”**.

“And as after this, surrounding conditions of actualization were everywhere established corresponding to the manifestation of the second particularity of the fifth Stopinder of the fundamental sacred Heptaparaparshinokh, therefore from then on the actualization of the fundamental outer cycle of the sacred Heptaparaparshinokh ceased, and all the action of its functioning entered forever into the results already manifested by it, and in them there began to proceed its inherent permanent processes of transformation, called ‘evolution’ and ‘involution.’”

We should also take into consideration the different meanings implied when Gurdjieff utilizes the terminology “fundamental sacred” versus just “sacred”. “Fundamental” or “fundamental sacred” refers to either the trinity of forces, or the forces originating in the Holy Sun Absolute. “Sacred” refers to the forces created in the Universe. Understanding Gurdjieff’s terminology will make it easier to comprehend Gurdjieff’s cosmology, as well as that which we shall now discuss.

If we again return to the diagram of the 19 octaves that create the Holy Sun Absolute and the Universe (page 103), we can discover a new structure emerging by following another part of Gurdjieff’s remarkable treatise.

“At this very place in the process of the first outer cycle of the fundamental sacred Heptaparaparshinokh, namely, after the formation of the Third-order-Suns or planets, just here, owing to the changed fifth deflection of the sacred Heptaparaparshinokh, which as I have already said is now called Harnel-Aoot, the initially given momentum for the fundamental completing process, having lost half the force of its vivifyingness, began in its further functioning to have only half of the manifestation of its action outside itself, and the other half for itself, i.e., for its very own functioning, the consequences of which were that on these last big results, i.e., on these said Third-order-Suns or planets, there began to arise what are called, ‘similarities-to-the-already-arisen.’”

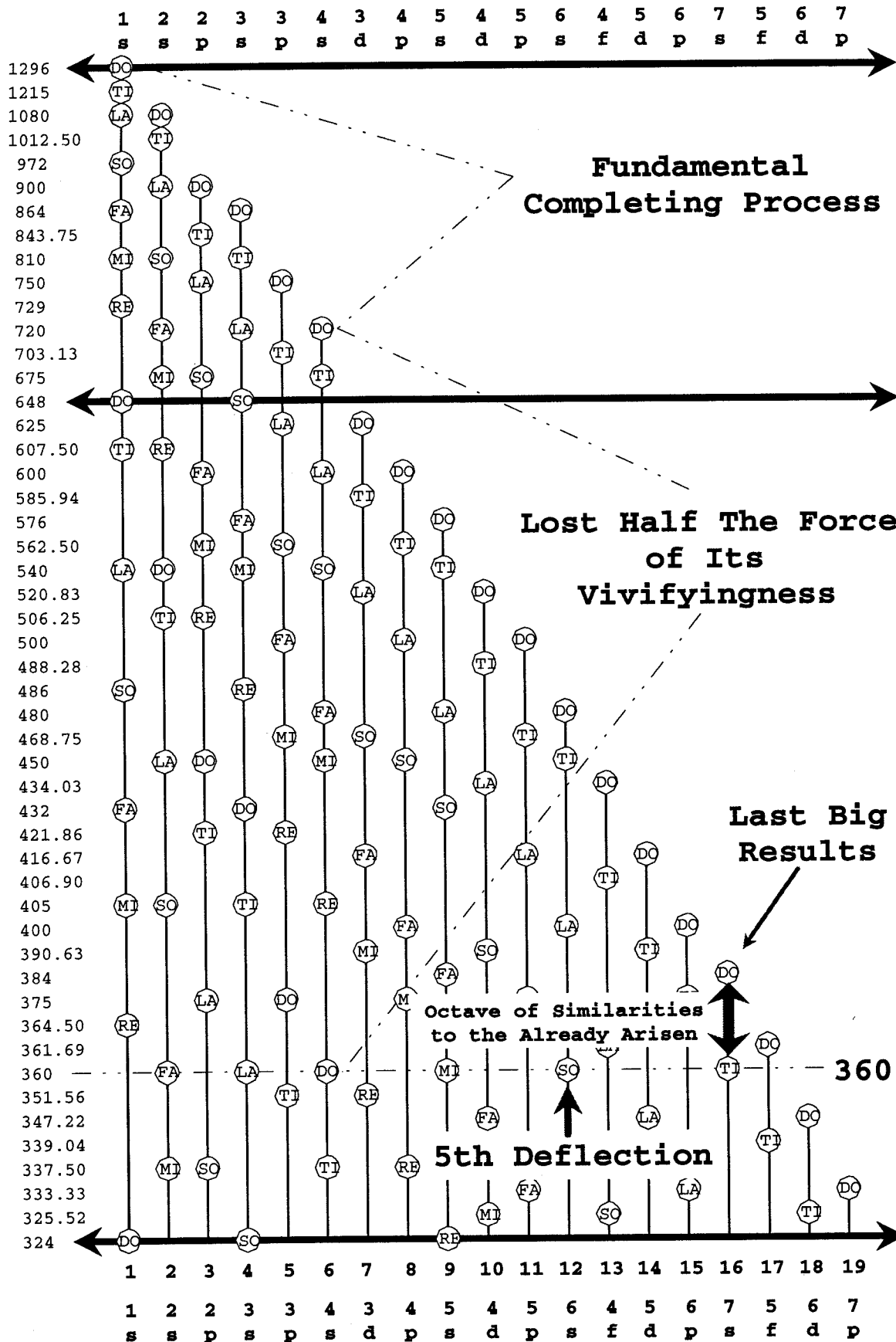

The six octaves that originate in the Holy Sun Absolute constitute the octaves of the “fundamental completing process”. Notice again, the terminology “fundamental” as indicative of their originating in the Holy Sun Absolute. In addition, Gurdjieff uses the terminology, “fundamental sacred”, to also indicate these octaves, in the phrase “fundamental sacred Heptaparaparshinokh”.

If we examine these six fundamental octaves and ask “**Where does the ‘fundamental completing process’ lose half the force of its vivifyingness?’**”; we can conclude, since all six of these octaves represent the “fundamental completing process”, that not until *all six have lost half the force of their vivifyingness* can we say that *the “fundamental completing process” has lost half the force of its vivifyingness*. Therefore, when the 4s octave at 720 vibrations reaches 360 vibrations, a halving of the “fundamental completing process” is achieved.

Gurdjieff also indicates this vibration, 360, by using the terminology “fifth deflection of the sacred Heptaparaparshinokh”. If you recall, Gurdjieff uses the word “sacred” to indicate the octaves that originate in the Universe, while “deflection” specifically indicates a note and not a Stopinder. At 360 vibrations the 6s octave, a “sacred” octave, has reached the “fifth deflection”, the note SO; i.e., the last note of its Harnel-Aoot. In addition, five other octaves contain the vibration 360. All six are Supreme octaves. The last is the 7s octave, the sixteenth octave, which Gurdjieff calls “...these last big results”.

Notice that the TI of the sixteenth octave is at 360 vibrations. Earlier in this chapter, we explored the unique significance of the “intentionally-actualized-Mdnel-In”, the TI-DO interval. In addition, we also established that an inner octave arises between these two notes. In this inner octave (DO-TI), “...on these last big results...” (the 7s octave) a new structure--“similarities-to-the-already-arisen”--emerges.

**Question: What structure is similar to the “already-arisen”?**

**Answer: The structure that has “already arose”.**

The octave between DO-TI becomes a new 1s octave, similar to the original 1s octave, only on a smaller scale. In this new structure called “similarities-to-the-already-arisen”, *Life* emerges: amino-acids, RNA, DNA, and all that follows. Note: In the structure of the Universe--only nineteen outer octaves are created. In the structure of the “similarities-to-the-already-arisen”--octave creation is *infinite*.

Note regarding the Ray of Creation: The odd “s” octaves (1, 3, 5, and 7) are *analogous* to Great-Grandfather, Grandfather, Father, and Son. The Father (5s)--the first Supreme Octave in the Universe--*is* the Ray of Creation. The “mechano-coinciding-Mdnel-In”, FA-MI, of the 5s octave--COINCIDES--with the “intentionally-actualized-Mdnel-In”, TI-DO, of the 7s octave. TI-DO--*similarities*, is MI-FA--Organic Life.

Now, we begin a journey *beyond-beyond*. In chapter six we structured the three segments (the Absolute, the Holy Sun Absolute, and the Universe) as three descending octaves. If we now place these three octaves as the three inner octaves of some greater whole, we will find the greater whole is an all-to-nothing octave with its four fundamental points (**DO**, **SO**, **MI**, and **RE**) becoming the four **DO**'s of these three octaves. This greater "all to nothing" octave will have a duality; an oscillating **DO** at both **SO** and **MI**, each with the possibility of "ascension" and "descension". Notice that these two points of existence are at the boundaries between the **Holy Sun Absolute** and the **Absolute** and the **Holy Sun Absolute** and the **Universe**.

If we examine the arrows of **ascension** and **descension**, which correspond to these two points of existence, we find:

The note **SO**...ascends into the **Absolute** and descends into the **Holy Sun Absolute**.

The note **MI**...ascends into the **Holy Sun Absolute** and descends into the **Universe**.

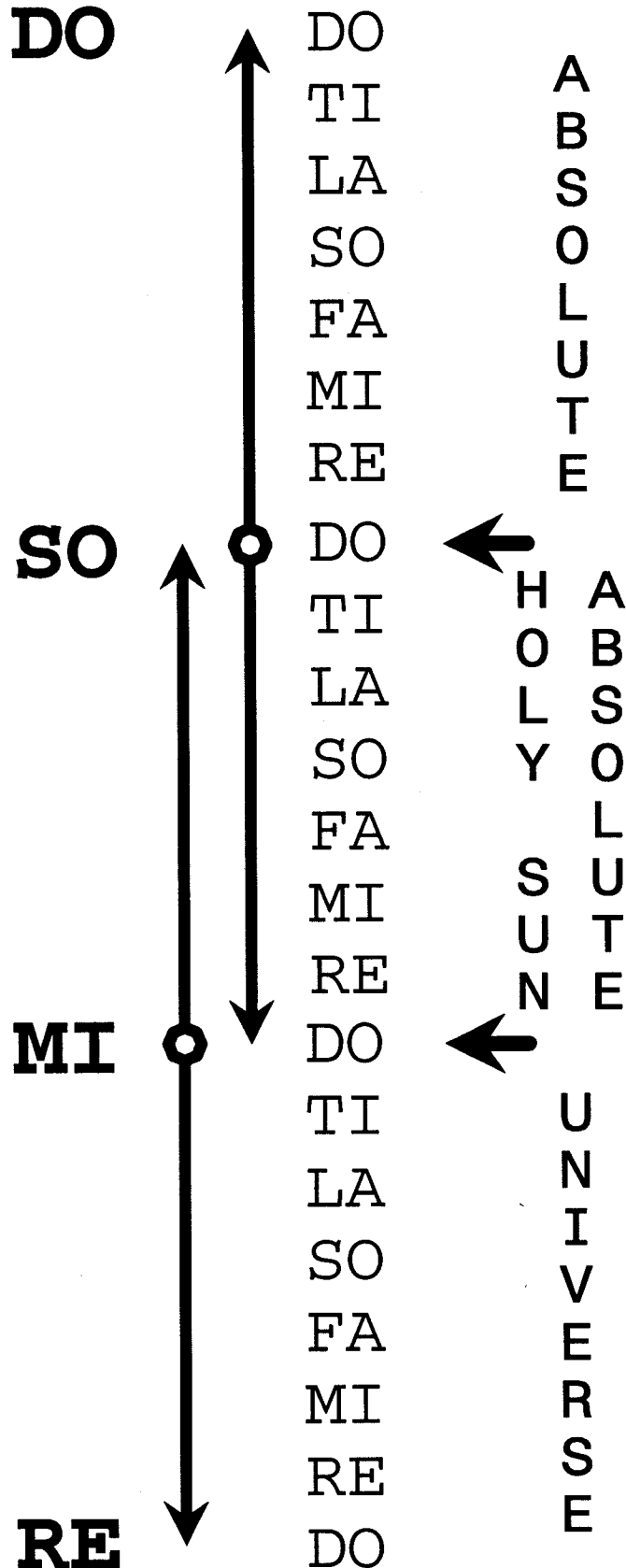

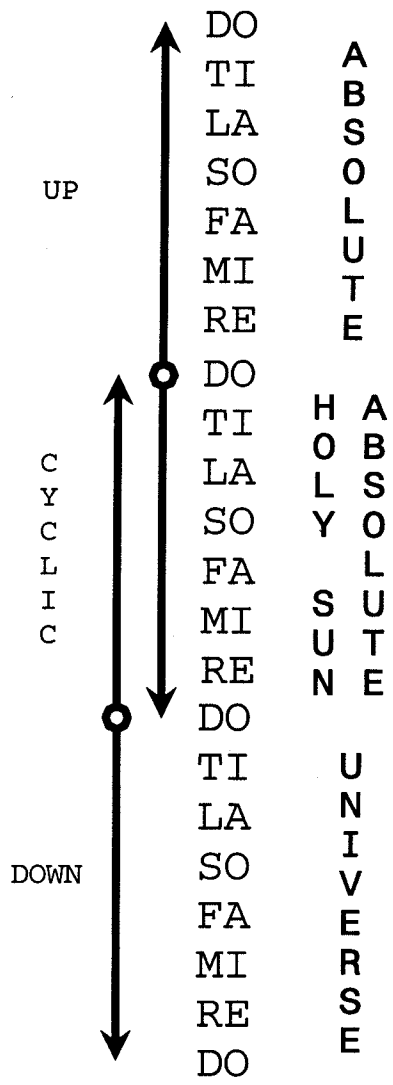

Next, by interpreting the arrows of ascension and descension that occur within the three octaves--the Absolute, the Holy Sun Absolute, and the Universe--we can make the following postulations:

1. *For the Universe everything falls to the bottom.*
2. *For the Absolute everything falls to the top.*
3. *For the Holy Sun Absolute things do not fall at all...but are held in the cyclical state of eternal unchanging.*

Notice that in the Universe there is only one arrow (the arrow of MI's descension); a downward arrow encompassing the entire Universe. It begins at DO, the top of the Universe, and flows to DO, the bottom of the Universe.

Is there anything in our Universe that is representative of this arrow? A force perhaps that can be perceived as a downward arrow...something manifesting in one direction? Indeed there is, and we call it "gravity".

Gravity is an attractive force; it never repels. Gravity is a force that always manifests in one direction, and since, in our Universe, all things fall in one direction, that is, to the bottom, we can surmise that the single arrow of MI's descension represents this force.

We have postulated that the arrow of MI's descension indicates the force of gravity in the Universe. Now, we shall explore this Octave-of-the-Universe, and diagram the "law conformable" structure created within it.

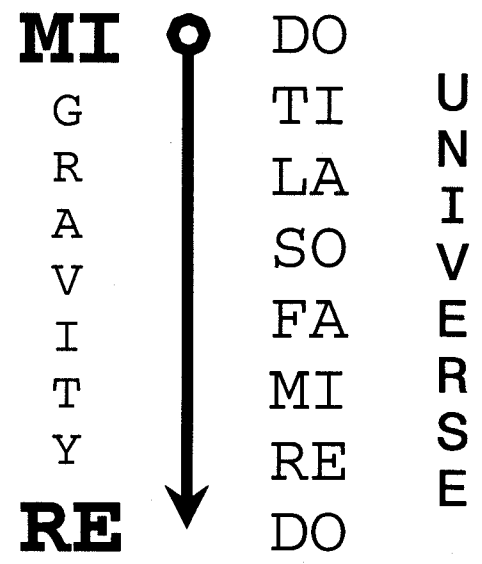

First, three octaves of radiations form between its four fundamental points.

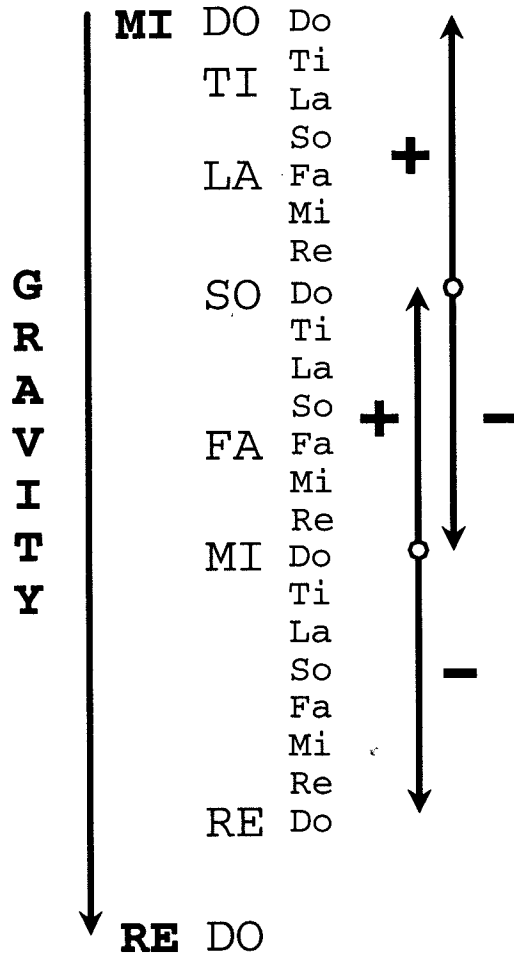

Second, another set of both ascending and descending arrows flows forth from its two points of existence--the duality--SO and MI. We shall call this new set of arrows--or lines of force--the "electrical force lines". In the "Octave-of-the-Universe" we discover that the "electrical force lines" can manifest in three ways--either positive; or negative; or they can coincide.

Here, where the electrical force lines coincide, in the, as we call it, "**MI-SO area of coincidence**" there is a unique manifestation. The electrical force circulates; and the circulation of an electrical force creates a magnetic field. Thus, magnetism is born. Note: The "MI-SO area of coincidence" also indicates the bipolar nature of magnets; why magnets always have two poles, north and south. Our galaxy [the world of suns, planets, and earths] is in this octave--the "Octave-of-the-bipolar-area-of-the-Universe"--SO to MI.

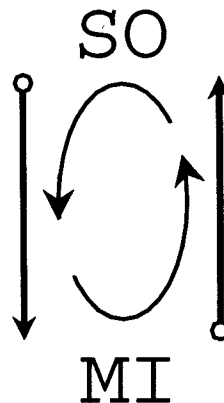

Pressing on into the “Octave-of-the-bipolar-area-of-the-Universe”, we find still more lines of force. We shall call these lines the “nuclear force lines”. In the nucleus of an atom, there are two nuclear forces, the strong nuclear force and the weak nuclear force. Perhaps someday, scientists will discover that the “Mi-So area of coincidence” of the nuclear force lines reveals a connection between the strong and weak nuclear forces; just as the “MI-SO area of coincidence” in the electrical force lines revealed the magnetic force.

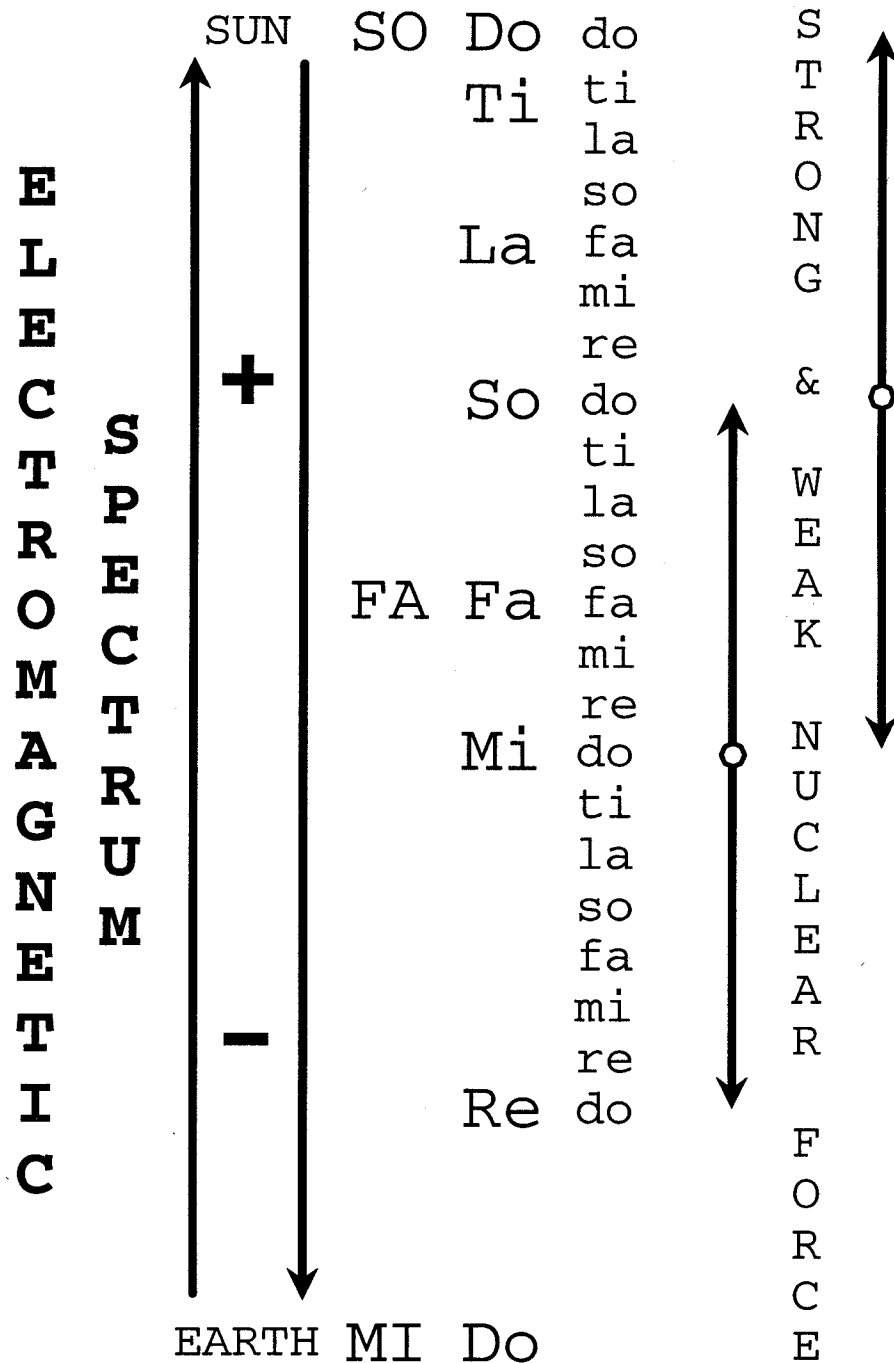

In addition, when we examine electricity and magnetism, we find that they are bound together by the speed of light; that is, the magnetic constant-- $K_m$ , multiplied by the speed of light-- $c$ , equals the electric constant-- $K_e$ ; or  $K_m c = K_e$ , or  $K_e = K_m c$ . Next, when we examine the force that binds atoms together, we find that here things manifest in relation to the square of the speed of light; that is, the mass-- $M$ , times the speed of light squared-- $c^2$ , equals the energy-- $E$ ; or  $M c^2 = E$ , or  $E = M c^2$ .

In scale-1 we discovered *gravity*, in scale-2 the *electromagnetic spectrum*, and in scale-3 the *strong and weak nuclear forces*. Someday scientists will unmask the next inner scale, the inner scale of quarks, and also discover that this scale has its own "mi-so area of coincidence". Perhaps it, too, is based on the speed of light; but--this time--will it be  $c^3$ , or possibly  $c^4$ ? Which one will it be? *Only the Law of Octaves knows, as well as, all who know the Law of Octaves!*



## THE AFTER MATH

That does it; we have finally reached the end of *this excavation* into the *third striving*: "the conscious striving to know ever more and more concerning the laws of World-creation and World-maintenance"; many dogs have been unearthed! So, put the shovel aside but do not let it rust, as we have more to uncover in this striving; and there are other strivings in which we may, someday, wish to dig. Forthwith, the mathematical veracity of the ideas encapsulated here necessitates individual participation and verification; thus, providing the accustomed traveler with much to contemplate, and the Man of "R-E-A-S-O-N" with a very good map. A delineation that clearly defines Man's position in the Universe, as well as indicates the possible path upon which Man's ultimate ascension, and indeed, Man's final re-emergence with his Creator proceeds; and, by the way, on which our common Father Almighty depends.

**ENDING**

**DO**

## CHAPTER SEVEN WORKSHEET

1. Identify the notes in the octaves below that share vibrations with the 9p octave.

### OCTAVES THAT SHARE VIBRATIONS WITH THE 9p OCTAVE

3p	3d	4p	5p	5d	6p	7p	7d	8p	9p	9d	10p	11p	11d	12p	13p	13d	14p	15p
									DO									
									TI									
									LA									
									SO									
									FA									
									MI									
									RE									
									DO									

A study of the 6p octave (page 135) will get you started. Notice, there are two patterns--the octaves aligning with the 6p's (FA-DO-SO-RE), and the octaves aligning with its (LA-MI-TI). In an octave, if (FA-DO-SO-RE) does one pattern--then (LA-MI-TI) does the other; that is, if you know one note you know all notes.

2. Identify the notes in the octaves below that share vibrations with the 7s octave.

### OCTAVES THAT SHARE VIBRATIONS WITH THE 7s OCTAVE

1s	2s	3s	4s	5s	6s	7s	8s	9s	10s	11s	12s	13s	14s
						DO							
						TI							
						LA							
						SO							
						FA							
						MI							
						RE							
						DO							

The Supreme Octaves have been reprinted on page 159 and can be used to find the octaves "before" the 7s octave; and...the other sequence (page 139).

# Supreme Vibrations and Related Octaves

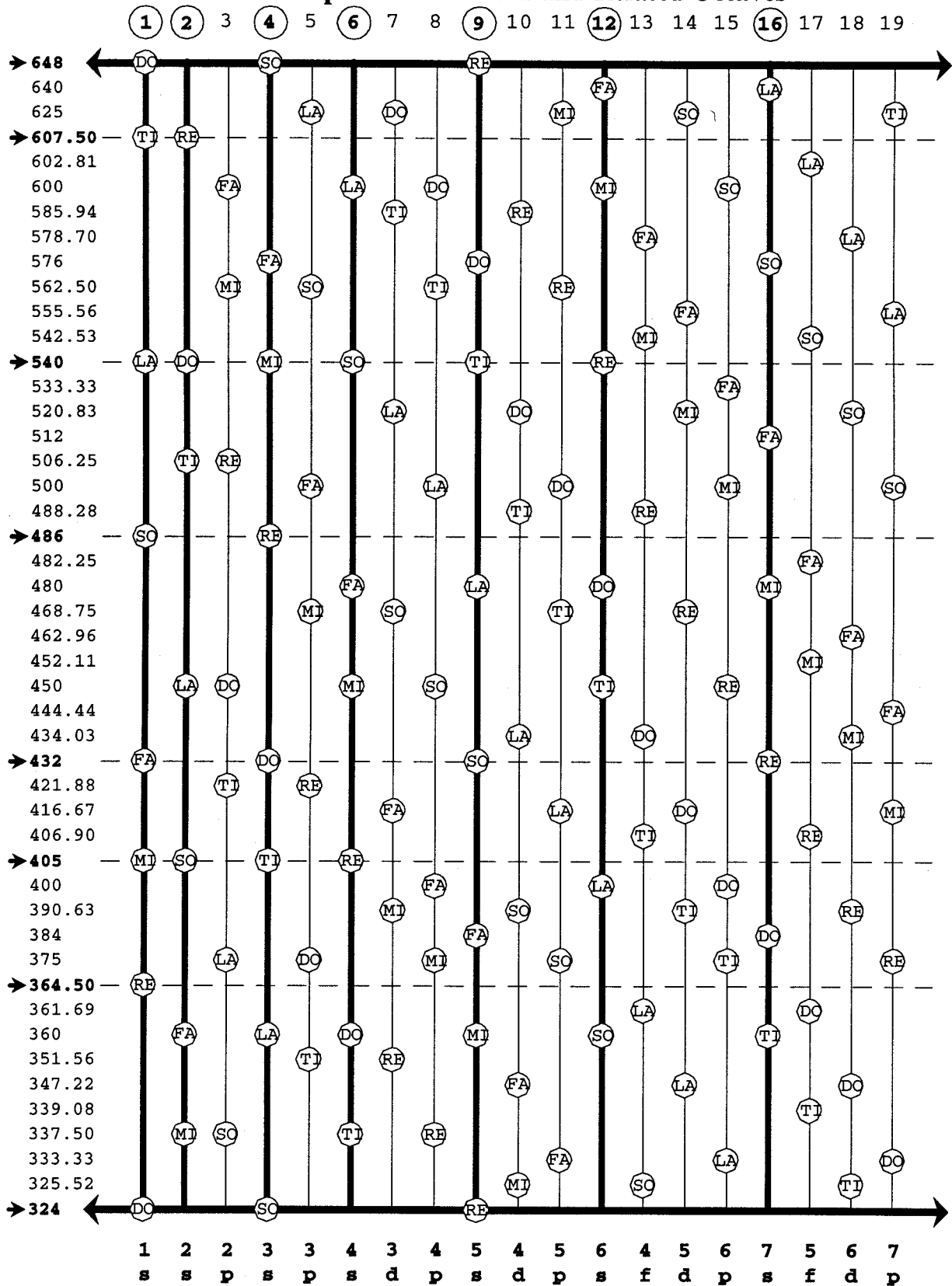

## ENDNOTES

<sup>1</sup> J. G. Bennett, Gurdjieff: Making a New World (New York: Harper & Row, 1976) 274.

<sup>2</sup> A collection from Gurdjieff's pupils, Views from the Real World (New York: Dutton, 1975) 194.

<sup>3</sup> G. I. Gurdjieff, Beelzebub's Tales to His Grandson/All and Everything, First Series, First Book (Oregon: Two Rivers, 1993) 385-386.

<sup>4</sup> G. I. Gurdjieff, Beelzebub's Tales to His Grandson/All and Everything, First Series, Second Book (Oregon: Two Rivers, 1993) 751.

<sup>5</sup> Ibidem 750-751.

<sup>6</sup> William Braid White, Mus. D., Piano Tuning and Allied Arts (Boston: Tuners Supply, 1977) 20.

<sup>7</sup> G. I. Gurdjieff, Beelzebub's Tales to His Grandson/All and Everything, First Series, Second Book (Oregon: Two Rivers, 1993) 748-750.

<sup>8</sup> G. I. Gurdjieff, Beelzebub's Tales to His Grandson/All and Everything, First Series, Second Book (Oregon: Two Rivers, 1993) 752-753.

<sup>9</sup> P. D. Ouspensky, The Fourth Way (New York: Vintage, 1971) 191.

<sup>10</sup> A collection from Gurdjieff's pupils, Views from the Real World (New York: Dutton, 1975) 140-141.

<sup>11</sup> G. I. Gurdjieff, Beelzebub's Tales to His Grandson/All and Everything, First Series, Second Book (Oregon: Two Rivers, 1993) 753-754.

<sup>12</sup> Ibidem 754.

13 P. D. Ouspensky, In Search of the Miraculous (Orlando: Harcourt Brace Jovanovich, 1977) 167.

14 G. I. Gurdjieff, Beelzebub's Tales to His Grandson/All and Everything, First Series, First Book (Oregon: Two Rivers, 1993) 123.

15 G. I. Gurdjieff, Beelzebub's Tales to His Grandson/All and Everything, First Series, Second Book (Oregon: Two Rivers, 1993) 780-781; 784; 786-792.

16 P. D. Ouspensky, In Search of the Miraculous (Orlando: Harcourt Brace Jovanovich, 1977) 323.

17 G. I. Gurdjieff, Beelzebub's Tales to His Grandson/All and Everything, First Series, Second Book (Oregon: Two Rivers, 1993) 756.

18 G. I. Gurdjieff, Beelzebub's Tales to His Grandson/All and Everything, First Series, Second Book (Oregon: Two Rivers, 1993) 752-758.

19 P. D. Ouspensky, The Fourth Way (New York: Vintage, 1971) 25-26.

20 G. I. Gurdjieff, Beelzebub's Tales to His Grandson/All and Everything, First Series, Third Book (Oregon: Two Rivers, 1993) 830-831.

# FOUNDATIONAL LITERATURE

**Gurdjieff, G. I.**

MEETINGS WITH REMARKABLE MEN

(New York: Dutton, 1969)

LIFE IS REAL ONLY THEN, WHEN "I AM"

(New York: Dutton, 1981)

VIEWS FROM THE REAL WORLD--EARLY TALKS OF GURDJIEFF

(New York: Dutton, 1975)

BEELZEBUB'S TALES TO HIS GRANDSON/ALL AND EVERYTHING

(Oregon: Two Rivers, 1993)

**Ouspensky, P. D.**

THE FOURTH WAY

(New York: Vintage, 1971)

IN SEARCH OF THE MIRACULOUS

(New York: Harcourt, 1977)

CONSCIENCE--THE SEARCH FOR TRUTH

(New York: Arkana, 1988)

THE PSYCHOLOGY OF MAN'S POSSIBLE EVOLUTION

(New York: Vintage, 1974)

**Bennett, Elizabeth**

IDIOTS IN PARIS

(England: Coombe Springs, 1980)

**Bennett, J. G.**

**TRANSFORMATION**

(West Virginia: Claymont, 1978)

**THE SEVENFOLD WORK**

(West Virginia: Claymont, 1979)

**TALKS ON BEELZEBUB'S TALES**

(Maine: Weiser, 1988)

**GURDJIEFF: MAKING A NEW WORLD**

(New York: Harper & Row, 1976)

**Nicoll, Maurice**

**THE MARK**

(Colorado: Shambhala, 1985)

**THE NEW MAN**

(Colorado: Shambhala, 1986)

**PSYCHOLOGICAL COMMENTARIES ON THE TEACHING**

**OF GURDJIEFF & OUSPENSKY, Volumes I-V**

(Colorado: Shambhala, 1984)

**Speeth, Kathleen, and Ira Friedlander**

**GURDJIEFF--SEEKER OF THE TRUTH**

(New York: Harper & Row, 1980)

# INDEX OF TERMS

- Affirming force [principle]-----15, 17, 57-59, 74, 76-77  
 All(ness) to Nothing(ness)- 7, 12, 36-37, 40-42, 53, 60, 152  
 Anti-codon loop-----61-62, 66  
 Ascending Do -----5-7, 37-39, 52, 140, 145  
 Ascending octave -----18, 55, 78  
 Atom(s)----- 3, 54, 56, 59-60, 116-117, 155-156
- Bottom-Re -----37, 145-146  
 Boundaries -----86, 94, 106, 152  
 Brain(s)-----17, 71, 82-83, 99-100, 140-142
- Chord -----3, 78-79  
 Codon-----61, 66  
 Commencement of a new cycle-----25-26, 98, 145  
 Cosmic rumple -----24, 28
- Deck of Cards -----43-49, 140, 142  
 Denying force [principle]-----15, 17, 57-59, 68, 74, 76-77  
 Descending Do -----5-7, 37-39, 52, 140  
 Descending octave -----18, 55, 78, 94, 102, 106, 141, 152  
 DNA -----46, 61, 66, 68-69, 71, 135, 151  
 Duality(ties)-----29, 53-54, 57, 59, 66-67, 76, 117-118, 120-127, 152, 154
- Electromagnetic spectrum-----54, 155-156  
 Emotional center -----17, 44-45, 137, 141-143  
 Evolution(ary)-----46, 53, 71, 73, 80-81, 83-84, 107, 149
- Fundamental completing process-----102, 149-151  
 Fundamental law(s)-----2-3, 11, 14-15, 25, 97-101  
 Fundamental outer cycle-----102, 106, 108, 146, 149, 151  
 Fundamental points-----35-38, 41-42, 143-144, 152, 154
- God-----iv, 2, 9, 24, 92  
 Gravity-----3, 153-154, 156  
 Gurdjine -----132
- Harmonic stability -----57-58  
 Higher emotional center -----17, 44-45, 137, 141-143  
 Higher mental center -----17, 44-45, 137, 141-143
- Inner Ansapalnian-octave-----121, 130-131  
 Instinctive center -----17, 44-46, 137, 141, 143  
 Intellectual center -----17, 44-45, 137, 141, 143  
 Involution(ary) -----53, 73, 80, 102, 149
- Joker(s) -----43-45, 140, 142-143
- Law conformable successiveness -----23, 25-26, 98  
 Laws of World-creation and World-maintenance -- iii, 1, 28, 47, 76, 86, 91, 135, 156
- Magnetism-----54, 154, 156  
 Major oscillation(s)-----58-60, 64, 67-68, 85-86, 136-138  
 Minor oscillation(s)-----58-60, 67-68  
 Moving center-----17, 44-45, 71, 137, 141, 143
- Neutralizing force [principle] -----15, 17, 57, 76-77
- Octave-of-the-bipolar-area-of-the-Universe-----154-155  
 Octave of Brains-----142  
 Octave of the Cards-----45, 49, 143  
 Octave of Higher Mental Center-----142  
 Octave of Life-----68, 141  
 Octave of Man-----140, 142  
 Octave-of-the-Universe-----153-154  
 Oscillating Do -----37, 39, 41, 52-53, 58, 60, 152
- Part(s) -----iii, 40-41, 45-47  
 Pause -----39  
 Phenomenon -----8, 67-68, 145  
 Previous [unknown] scale-----iii, 42-44, 140, 142-143
- Quarks -----3, 56, 135, 156
- RNA -----46, 60-62, 65-66, 68, 135, 151  
 Reconciling force [principle]-----15, 57, 74, 76
- Sevenfold -----4, 45, 143  
 Seven centers-----17, 44, 137, 140  
 Sex center-----17, 44-45, 137, 141, 143  
 Shock(s) -----9, 29, 75, 78, 84-88  
 Single octave/force-----73, 94, 97  
 Sixteenth octave -----108, 151  
 Spiritual/Spirituality -----iv-v, 45, 141
- Three-story factory -----17, 138  
 Totality(ties) -----iii, 6-8, 18-19, 26, 36-39, 50, 81-84, 94, 101, 125, 131
- Unique(ly)(ness)-----14, 37, 39, 52, 55, 60-61, 98, 104, 151, 154
- Vivifyingness -----84, 86, 102, 149-151
- Whole Phenomenon-----2, 7, 36, 94

# INDEX OF DIAGRAMS

Absolute [primordial]-----	94	Octave in Three Scales [mathematical] -----	39, 42, 48
Absolute [mathematical]-----	94	Octave in Three Scales [symbolic-cards] -----	45, 48, 49
Absolute [symbolic]-----	91, 92, 97	Octaves in the Universe -----	116
Absolute--Holy Sun Absolute--Universe -----	94	Octave Lengths [two scales] -----	38
An Atom's Energy Shells in Octave Order-----	117	Octave of 48 To 24-----	36
An Octave at Every Note-----	139	Octaves of 24 And 48-----	8
Ascending and Descending Ratios -----	6	Oscillation in Seventy-one Vibrations-----	60
Boundaries of Creation [mathematical] -----	106	Oscillation in Four Scales -----	63
Completing the Periodic Table of Elements-----	121-130	Oscillations and Centers -----	137
Creation-----	24, 25	Oscillations in an Octave's Three Scales -----	67
Creation in Progress -----	23	Oscillation Shapes as tRNA-----	61, 62, 65, 66
Diagram of Nutrition -----	85	Outer Octaves and Common Vibrations -----	135, 138, 144
Diatonic Scale -----	6	Pascal's Triangle-----	104
Diatonic Structure of the Universe -----	110	Prime Vibrations and Related Octaves-----	112
Distant Vibrations and Related Octaves-----	113	Progression of Forces -----	108
DNA-----	69	Pythagorean Harmonies -----	5
Electrical Force Lines-----	154	Ratios After Separation-----	18
Electromagnetic Spectrum-----	155	Ratio of Shocks-----	78
Enneagram [diatonic]-----	88	Ray of Creation -----	35
Enneagram's Mathematics-----	20, 21	Ribosomal RNA -----	77
Enneagram [symbolic] -----	2, 3, 16, 87	Scale-0, Scale-1-----	37
Eternal Unchanging [symbolic]-----	91, 104	Scale-2 Calculations -----	39
Even Sevenths -----	22	Separation of the Three Forces -----	16
Family Connections-----	119	Similarities to the Already Arisen-----	150
Fibonacci Series -----	105	Six Triads -----	15
Final Vibrations and Related Octaves-----	114	SO's Existence -----	55
Finding the Duality -----	53	Spiritual-Physical...Life-----	141
Folding An Oscillation -----	64	Strong and Weak Nuclear Forces -----	155
Four Boundaries/Three Segments -----	94	Supreme Vibrations and Related Octaves -----	111
From One Comes Seven Comes Forty-nine ---	143, 144, 145	The Harnel-Aoot and the Ceasing of the Fundamental Outer Cycle -----	148
Gravity-----	153	The Octave at Three Forces -----	19
Holy Sun Absolute [mathematical]-----	95, 96	The Periodic Table of Elements -----	130
Inevitability of Oscillations -----	57	The Sequence-----	138
Magnetism and the MI-SO Area of Coincidence-----	154	The Seventh Triad -----	16
Major and Minor Oscillations-----	59	The Ultimate All-to-Nothing Octave -----	152
Mathematics of the Duality-----	54	The Unique Mathematical Progression-----	104
MI's Existence-----	56	The Universal Cosmic Weave -----	103, 109
Middle C to High C-----	7	The Unknown Scale-----	142, 143
Nine Became Seven-----	28	The Way Down -----	74
Nineteen Octaves' Points of Creation-----	105	The Way Up-----	75
Notes Created per Scale -----	42	Three Scales, Thirteen Octaves, Seventy-one Vib. ---	40, 41
Obligatory-Gaps -----	136	Top, Middle, Bottom-----	52
Octaves Containing a 7s Vibration -----	140	Totality of 24 -----	36
Octave in Seventy-one Vibrations -----	58	Totality of Vibrations -----	7
		Transitional Symbol of Three Circles -----	93
		United and Separated Forces-----	18, 19
		Up, Down and Cyclic -----	153
		Wholeness Between Each Note-----	26, 27
		Wholeness of the Octave -----	27

An organization of **Theological Harmonistic Exercitations** into the **Discoveries Of Gurdjieff, THE DOG**, was founded in 1980 by Russell A. Smith.

*ITS PURPOSE:*

To discern,  
with objectively impartial cohesiveness,  
the writings of G. I. Gurdjieff.

Individuals interested in pursuing the "Gurdjieff Answers" contact:

**THE DOG**  
Route 1, Box 619  
Sanger, TX 76266

*Gurdjieff:*

# COSMIC SECRETS

Russell A. Smith

"HE HIMSELF [GURDJIEFF] USED TO LISTEN TO CHAPTERS READ ALOUD  
AND IF HE FOUND THAT THE KEY PASSAGES WERE TAKEN TOO EASILY  
—AND THEREFORE ALMOST INEVITABLY TOO SUPERFICIALLY—  
HE WOULD REWRITE THEM IN ORDER, AS HE PUT IT, TO 'BURY THE DOG DEEPER'.  
WHEN PEOPLE CORRECTED HIM AND SAID THAT HE SURELY MEANT  
'BURY THE BONE DEEPER', HE WOULD TURN ON THEM AND SAY

IT IS NOT 'BONES' BUT THE 'DOG' THAT YOU HAVE TO FIND." <sup>1</sup>

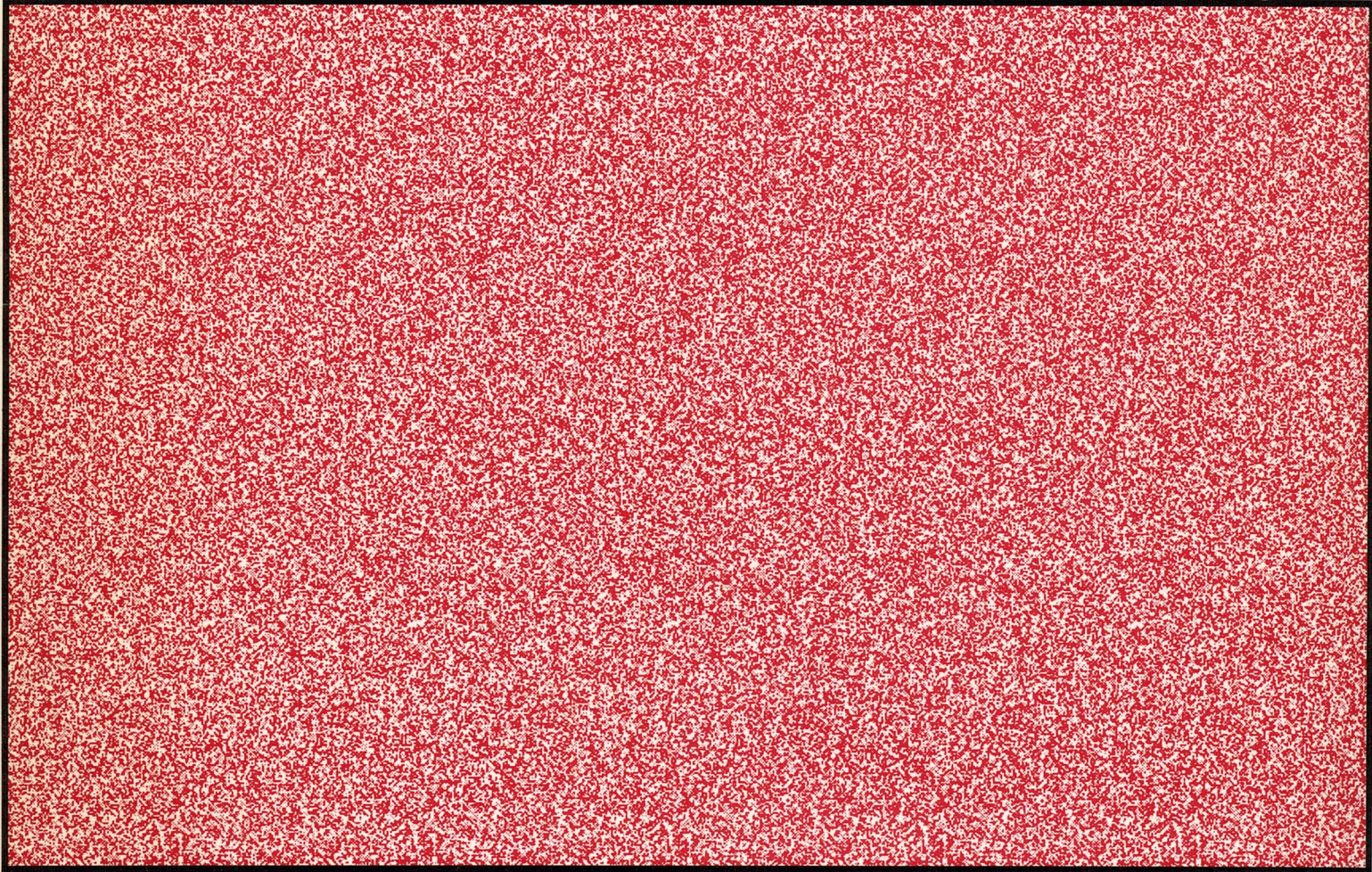

**T H E**  
  
**D O G**

ISBN 0-9643031-0-8 '24.48

ISBN 0-9643031-0-8



9 780964 303102

5 2 4 4 8

